



SPORLAN

Catch-All®

Liquid & Suction Line Filter-Driers



Catch-All®

FILTER-DRIERS

It's the CORE that counts!



ENGINEERING YOUR SUCCESS.



The Sporlan **Catch-All®** **Liquid and Suction Line Filter-Driers** are the choice for today's systems with

R-410A

Table of Contents

Quick Selection Guide	3
Technical Information	
System Chemistry	4
The Catch-All Filter-Drier	5
Application	8
Sealed Model Catch-All Filter-Driers	
Specifications	10
Ratings and Selection.	12
Reversible Heat Pump Filter-Driers	19
Replaceable Core Catch-All Filter-Driers	
Features	23
Specifications	24
Cores and Filter Elements	26
Ratings and Selection.	28
HH Style Catch-Alls For Wax Removal	33
Suction Line Filter-Driers	
Application	34
Specifications	36
Compact Style Suction Line Filter-Driers	40
Acid Test Kit	42
Accessories	43
ATEX Compliance	44
Terms of Sale With Warranty Limitations	45

⚠ WARNING – USER RESPONSIBILITY

Failure or improper selection or improper use of the products described herein or related items can cause death, personal injury and property damage.

This document and other information from Parker Hannifin Corporation, its subsidiaries and authorized distributors provide product or system options for further investigation by users having technical expertise.

The user, through its own analysis and testing, is solely responsible for making the final selection of the system and components and assuring that all performance, endurance, maintenance, safety and warning requirements of the application are met. The user must analyze all aspects of the application, follow applicable industry standards, and follow the information concerning the product in the current product catalog and in any other materials provided from Parker or its subsidiaries or authorized distributors.

To the extent that Parker or its subsidiaries or authorized distributors provide component or system options based upon data or specifications provided by the user, the user is responsible for determining that such data and specifications are suitable and sufficient for all applications and reasonably foreseeable uses of the components or systems.

OFFER OF SALE

The items described in this document are hereby offered for sale by Parker Hannifin Corporation, its subsidiaries or its authorized distributors. This offer and its acceptance are governed by the provisions stated in the detailed "Offer of Sale" available at www.parker.com.

FOR USE ON REFRIGERATION and/or AIR CONDITIONING SYSTEMS ONLY

Bulletin 40-10, February 2015, supersedes Bulletin 40-10, January 2011, and all prior publications.



Liquid Line Quick Selection Recommendations

SYSTEM SIZE		FIELD REPLACEMENT			
TONS	LINE SIZE Inches OD	AIR CONDITIONING		REFRIGERATION	
		R-12 & R-134a	R-22, R-407C & R-410A*	R-12, R-134a, R-404A, R-502 & R-507	R-22
SEALED TYPES - SPECIFY FLARE OR SOLDER					
1/4 - 1/3	CAP TUBE	C-032-CAP	C-032-CAP	C-032-CAP	C-032-CAP
	1/4	C-032(-S)	C-032(-S)	C-032(-S)	C-032(-S)
1/2 - 1	1/4	C-052(-S)	C-052(-S)	C-082(-S)	C-082(-S)
	5/16	C-0525-S	C-0525-S	C-0825(-S)	C-0825-S
	3/8	C-053(-S)	C-053(-S)	C-083(-S)	C-083(-S)
1-1/2 - 2-1/2	5/16	C-0825-S	C-0825-S	C-1625-S	C-1625-S
	3/8	C-083(-S)	C-083(-S)	C-163(-S)	C-163(-S)
	1/2	C-084(-S)	C-084(-S)	C-164(-S)	C-164(-S)
3 - 6	5/16	C-1625-S	C-1625-S	—	—
	3/8	C-163(-S)	C-163(-S)	C-303(-S)	C-303(-S)
	1/2	C-164(-S)	C-164(-S)	C-304(-S)	C-304(-S)
	5/8	C-165(-S)	C-165(-S)	C-305(-S)	C-305(-S)
7 - 9	1/2	C-304(-S)	C-304(-S)	C-414(-S)	C-414(-S)
	5/8	C-305(-S)	C-305(-S)	C-415(-S)	C-415(-S)
	7/8	C-307-S	C-307-S	C-417-S	C-417-S
10 - 12	1/2	—	C-414(-S)	—	C-414(-S)
	5/8	C-415(-S)	C-415(-S)	C-415(-S)	C-415(-S)
	7/8	C-417-S	C-417-S	C-417-S	C-417-S
	1-1/8	C-419S	C-419S	C-419-S	C-419-S
13 - 18	5/8	—	C-415(-S)	—	C-415(-S)
	7/8	C-607-S	C-607-S	C-607-S	C-607-S
	1-1/8	C-609-S	C-609-S	C-609-S	C-609-S
REVERSIBLE HEAT PUMP FILTER-DRIER					
1-5	3/8	—	HPC-103-S / HPC-163-S-HH	—	—
	1/2	—	HPC-104-S / HPC-164-S-HH	—	—
	5/8	—	HPC-165-S-HH	—	—
5-16	3/8	—	HPC-303-S-HH / HPC-304-S-HH	—	—
	1/2	—	HPC-305-S-HH / HPC-307-S-HH	—	—
	5/8	—	—	—	—
	7/8	—	—	—	—
REPLACEABLE CORE TYPES					
4 - 9	5/8	C-485-G	C-485-G	C-485-G	C-485-G
	7/8	C-487-G	C-487-G	C-487-G	C-487-G
10 - 15	5/8	—	C-485-G	—	C-485-G
	7/8	C-487-G	C-487-G	C-487-G	C-487-G
	1-1/8	C-489-G	C-489-G	C-489-G	C-489-G
16 - 29	7/8	C-967-G	C-967-G	C-967-G	C-967-G
	1-1/8	C-969-G	C-969-G	C-969-G	C-969-G
	1-3/8	C-9611-G	C-9611-G	C-9611-G	C-9611-G
30 - 39	7/8	—	C-967-G	—	C-967-G
	1-1/8	C-1449-G	C-969-G	C-1449-G	C-969-G
	1-3/8	C-14411-G	C-9611-G	C-14411-G	C-9611-G
40 - 59	1-1/8	C-1449-G	C-1449-G	—	C-1449-G
	1-3/8	C-19211-G	C-14411-G	C-19211-G	C-14411-G
	1-5/8	C-19213-G	C-14413-G	C-19213-G	C-14413-G
60 - 75	1-1/8	—	C-1449-G	—	—
	1-3/8	C-19211-G	C-19211-G	C-19211-G	C-19211-G
	1-5/8	C-19213-G	C-19213-G	C-19213-G	C-19213-G
76 - 99	1-3/8	—	C-19211-G	—	C-19211-G
	1-5/8	C-30013-G	C-19213-G	C-30013-G	C-19213-G
	2-1/8	C-40017-G	C-19217-G	C-40017-G	C-19217-G
100 - 130	1-5/8	—	C-30013-G	—	C-30013-G
	2-1/8	C-40017-G	C-40017-G	C-40017-G	C-40017-G
131 - 150	2-1/8	(2) C-30017-G	C-40017-G	(2) C-30017-G	C-40017-G



CATCH-ALL SIZE	NO. OF CORES	SECONDARY FILTER	CORE TYPE
C-R420 Series Shell	1	—	RCW-42
C-480 Series Shell	1	FS-480	RCW-48, RC-4864, or RC-4864-HH
C-960 Series Shell	2	FS-960	
C-14400 Series Shell	3	FS-1440	
C-19200 Series Shell	4	FS-19200	RCW-100, RC-10098, or RC-10098-HH
C-30000 Series Shell	3	—	
C-40000 Series Shell	4	—	



*C-30000 and C-40000 Series shells are not approved for R-410A.



Why Chemical Breakdown Occurs



MOISTURE

Water or moisture is always present in refrigeration systems, especially with the use of hygroscopic polyolester (POE) lubricants. Acceptable limits vary from one unit to another and from one refrigerant to another. Moisture is harmful even if “freeze-ups” do not occur. Moisture is an important factor in the formation of acids, sludge, copper plating, and corrosion. To be **safe** and **sure**, keep the moisture level as low as possible.



DIRT

Dirt, oxide, scale, sludges, flux, and metallic particles are frequently found in refrigeration systems. Numerous metallic contaminants — cast iron dust, rust, scale, steel, copper, and brass chips — can damage cylinder walls, bearings, and plug capillary tubes or thermostatic expansion valve screens. In addition to mechanical damage and “plug-ups,” these contaminants catalyze chemical reactions that contribute to decomposition of the refrigerant-lubricant mixture at elevated temperatures.



ACIDS

Refrigerants by themselves are very stable, even when heated to a high temperature. However under some

conditions, reactions do occur which can result in the formation of acids. For example, Refrigerant 22 will decompose at high temperatures to form hydrochloric acid where an “acid acceptor” such as electrical insulation paper is present. The reaction of refrigerants with water may cause hydrolysis and the formation of hydrochloric and hydrofluoric acids. These acids are usually present as a gas in the system and are highly corrosive. In ordinary usage this reaction is negligible, but in a very wet system operating at abnormally high temperatures, some hydrolysis may occur.

All of these reactions are increased by elevated temperature and are catalytic in effect, resulting in the formation of corrosive compounds.

Another significant source of acidity in refrigeration systems is organic acid formed from lubricant breakdown. Acid is formed when POE lubricant reacts with moisture. Appreciable amounts of **organic acid** are found in lubricant samples analyzed in our laboratory. Since acids corrode metals in a system, they must be removed.

SLUDGE AND VARNISH

Although the utmost pre-caution may be taken in the design and fabrication of a system, once in operation, unusually high discharge temperatures will cause

the lubricant to breakdown. By-products of mineral/alkylbenzene lubricant decomposition are varnish, sludge, and possibly carbonaceous powder.

Temperatures may vary in different makes of compressors and under different operating conditions. While temperatures of 265°F/129°C are not unusual at the discharge valve under normal operation, temperatures well above 300°F/149°C frequently occur under unusual conditions. Common sources of high temperatures in refrigeration systems are dirty condensers, non-condensable gases in the condenser, high compression ratio, high superheat of suction gas returned to compressor, fan failure on forced convection condensers, and others.

In addition to high discharge temperatures, there are certain **catalytic metals** that contribute to the lubricant-refrigerant mixture breakdown. The most noted of these in a refrigeration system is iron. It is used in one form or another in all systems and is an active catalyst. Copper is in the same category as iron, but its action is slower. However, the end result is the same. This reaction causes sludge formation and other corrosive materials that will hinder the normal operation of compressor valves and control devices. **In addition, air in a system will accelerate the deterioration of the lubricant.**



Catch-All®

How It Works



The famous molded porous core of the Catch-All® Filter-Drier performs these vital functions:

REMOVES MOISTURE

The *Catch-All Filter-Drier* removes moisture from the refrigerant and lubricant by adsorbing and retaining moisture deep within the desiccant granules. The blend of desiccants used in the Catch-All is specially formulated for exceptional moisture removal. The high degree of activation ensures maximum water capacity, which means the core removes a large amount of water in one pass, thereby protecting the expansion valve from possible freeze-up. Since the refrigerant must flow through the core, maximum contact between the two ensures rapid system dehydration.

REMOVES FOREIGN MATTER

Scale, solder particles, dirt, and all types of foreign substances must be removed to protect the compressor, solenoid valves,

expansion valves, capillary tubes, and other close tolerance parts of a refrigeration system.

The solution to system filtration is the Catch-All Filter-Drier. The Catch-All has been designed to do the job with maximum efficiency. It removes these particles, down to the minimum size, in one pass filtration. Furthermore, the large filtering surface available on the core results in the ability to collect a large amount of dirt with negligible pressure drop. If plugged, the Catch-All will not burst allowing trapped substances back into the system.

REMOVES ACIDS

The *Catch-All Filter-Drier* is unexcelled in acid removal ability. The hydrochloric, hydrofluoric, and various organic acids found in used oil samples are harmful in a system. These acids are adsorbed and

remain on the desiccant in a manner similar to the adsorption of moisture.

Laboratory tests have shown that the Catch-All Filter-Drier's desiccant has an acid removal ability superior to other desiccants used in other refrigeration driers. Compared to other filter-driers designed for today's systems, tests show the *Catch-All Filter-Drier* removes much more acid (on an equal weight basis).

The Catch-All has demonstrated excellent field performance in cleaning up severely contaminated systems, whether due to acid, lubricant breakdown, or to hermetic motor burnout. Its success in field service work and in protecting new systems is largely due to its outstanding ability to remove acid and the products of lubricant breakdown.

REMOVES SLUDGE AND VARNISH

Even the best refrigeration lubricants frequently break down to produce organic acids and possibly varnish and sludge. These products of lubricant decomposition, are formed due to excessive heat or air in the system. Varnish can plug small orifices and accumulate on compressor valves causing eventual valve failure.

The ability of various desiccants to remove these products of lubricant decomposition has been evaluated in sealed glass tubes. Of all the desiccants tested, only the desiccant used in the Catch-All Filter-Driers proved capable of removing the products of lubricant breakdown. This ability makes the Catch-All Filter-Drier highly effective in cleaning systems that have had a hermetic motor burnout, and in protecting new systems by preventing an accumulation of these lubricant breakdown products.

ORGANIC ACID REMOVAL ABILITY

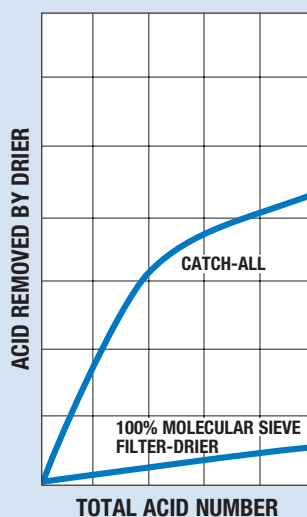



The Inside Story

CATCH-ALL FILTER-DRIERS PROVIDE THESE PROVEN BENEFITS:

BLEND OF DESICCANTS

Through constant engineering research, Sporlan developed a blend of desiccants that gives each core maximum contaminant removal characteristics for today's systems. Each core is formulated with molecular sieve for high water capacity and activated alumina for acid removal. A special grade of activated alumina granules is used to obtain the maximum ability to remove acids and products of lubricant breakdown. The overall result is balanced contaminant removal ability.



SPECIAL CHARCOAL BLEND

The HH core, which incorporates activated charcoal along with other desiccants, will remove wax, resins, and lubricant breakdown materials that normal desiccants do not remove. Therefore, this type of core is especially useful on low temperature systems when wax is suspected in the system or when wax-like substances are found in the metering device.

The HH style core has also found wide application for clean-up after a hermetic motor burnout where its ability to remove all types of contaminants is very advantageous. **BE SELECTIVE!** Choose a core designed for the specific application involved.

UNIFORM MOLDING

Sporlan pioneered the molded porous core. The core is carefully molded to assure a uniform porosity throughout the entire length and surface of the core. The granules of desiccant are carefully sized and controlled to obtain the proper porosity for maximum filtration ability.

SHOCKPROOF ASSEMBLY

The core is held in place by a heavy leaf spring at the inlet end of the Catch-All assembly. This spring holds the core in position and makes the assembly highly resistant to core breakage. The heavy spring gives a "pre-stressed effect" that significantly reduces the tendency of the core to break if the Catch-All is accidentally dropped.



NO BYPASSING

The core is sealed to the shell wall at the outlet end with a gasket or fibrous pad, which prohibits any possible bypassing of refrigerant around the core. All the flow passes through the core for maximum contaminant removal.

OUTLET SAFETY FILTER

A final "safety filter" is used in the outlet of every Catch-All. This involves either a specially developed polyester pad or 100 mesh screen that collects particles that might have rubbed off during assembly,



and serves as added protection in case the molded core is broken.

LEAKPROOF SHELL

The Catch-All shell is tig welded providing a very smooth, strong, entirely leakproof joint. The fittings are attached to the shell by copper brazing. This type of joint is one of the strongest and most reliable joining methods known. Each Catch-All is pressure tested in our factory to make sure that it does not leak. The overall result is a Catch-All with strong, entirely leakproof joints.

QUALITY FITTINGS

The flare fittings and solder fittings used on Sporlan Catch-Alls are inspected 100% during manufacture to make sure no defects are present. The solder fittings are copper fittings with reliable ID dimension for exact fit to the copper tubing. Flare fittings are nickel plated and their surfaces are smooth and free of scratches. Any imperfect flare fittings are resurfaced during manufacture.



BE SELECTIVE

In addition to being manufactured to high quality standards, the Catch-All has been designed specifically for field service work and OEM use. In situations requiring wax removal or clean-up after a hermetic motor burnout, choose the HH style Catch-All core, which is specifically designed for these applications.



Liquid Line

Ratings and Selection Recommendations

■ GENERAL

The selection of a filter-drier for a given application involves such technical factors as: the amount of moisture to be expected in a system — operating temperatures — amount of foreign matter present — allowable pressure drop through the filter-drier — its ability to retain both liquid and solid contaminants, and bursting pressure. Proper evaluation of these factors is necessary for optimum service and economy. As an aid, the important factors to be considered for selection purposes are discussed briefly in the following sections.

■ ATEX COMPLIANCE

For full ATEX compliance information, see page 44.

■ STANDARD RATINGS

ASHRAE-AHRI

The American Society of Heating, Refrigerating and Air Conditioning Engineers Standard 63, “Methods of Testing Liquid Line Refrigerant Driers,” sets up a test procedure to follow for determining the water capacity and refrigerant flow capacity under certain conditions. The Air Conditioning, Heating, and Refrigerating Institute subsequently issued AHRI Standard 710, which specifies the rating conditions for water capacity, refrigerant flow capacity, and safety requirements.

This Standard is intended to provide **comparison points** only. It is a basis for drier evaluation at the specified rating conditions, but does not attempt to govern the performance of a drier over the entire range of possible applications. It serves only to compare driers on their ratings for water capacity, refrigerant flow capacity, and safety requirements.

WATER CAPACITY

Water capacity is the amount of water (in drops or grams) that a drier will hold at the standard temperatures and equilibrium point dryness (EPD) specified. Twenty drops equal one gram, equal one

milliliter or one cubic centimeter.

Equilibrium Point Dryness (EPD) — is used to define the lowest possible water content in liquid refrigerant attainable by a filter-drier at a specific temperature after it has collected a specific quantity of water after equilibrium has been reached between the water in the refrigerant and the water in the drier. Equilibrium point dryness is expressed in parts per million (ppm) by weight.

REFRIGERANT FLOW CAPACITY

The maximum flow of liquid refrigerant (in tons) that a drier will pass at a 1 psi/0.07 bar pressure drop is the refrigerant flow capacity. The “ton” ratings are based on 86°F/30°C liquid temperature and refrigerant flows of...

- 3.1 lbs. per minute per ton for R-134a
- 3.0 lbs. per minute per ton for R-22
- 3.9 lbs. per minute per ton for R-404A
- 2.6 lbs. per minute per ton for R-407A
- 2.9 lbs. per minute per ton for R-407C
- 2.9 lbs. per minute per ton for R-407F
- 2.8 lbs. per minute per ton for R-410A
- 4.1 lbs. per minute per ton for R-507

SAFETY

Safety is based on drier shell bursting pressure. All liquid line driers manufactured under AHRI Standard 710 must meet the requirements of Underwriters’ Laboratories, Inc., Standard 207, “Refrigerant Containing Components and Accessories, Nonelectrical.”

■ SELECTION

When selecting a filter-drier the following should be considered:

WATER CAPACITY AND REFRIGERANT FLOW

Water capacity and refrigerant flow comparisons can be made on the basis of AHRI Standard data supplied by the manufacturer. **However, it should be remembered that flow ratings are based on the ideal situation of a completely clean system.** Flow is reduced as dirt accumulates on the filtering surface.

FILTRATION

Filtration characteristics of a filter-drier are not readily defined or evaluated since laboratory tests cannot reproduce the range of conditions and contaminants seen in an actual system. The ability to filter and **hold** foreign matter varies with the brand and type of filter-drier. The simplest guide to follow is that filter capacity is proportional to **filtering area**. In the tables that follow, the filtering areas of all Catch-All Filter-Driers are tabulated. Filters should be selected with an adequate reserve capacity to allow for the contamination found in most systems.

ACID REMOVAL

Acid Removal is also difficult to measure. There are no standard ratings to follow. However, both laboratory and field tests have demonstrated that the **Catch-All** core has superior acid removal ability — many times the acid capacity of competitive filter-driers developed for today’s systems.

■ SPORLAN RECOMMENDATIONS

Sporlan’s **Selection Recommendations** are based on the technical data currently available and more than 60 years of **field experience** with molded porous core filter-driers. Satisfactory results will be obtained with the sizes recommended for all normal refrigeration systems. We have considered the difference in requirements for air conditioning and refrigeration applications. Recommendations for these categories are made on pages 12 through 16 and pages 25 through 28. Recommendations for suction line use of filter-driers are in Form 40-109. Form 40-109 is a quick reference guide for suction line filter-drier selection.

Drier manufacturers establish ratings for their product, but...the final selection of the correct drier should be based on the conditions expected for each job. Consideration should be given to providing extra water capacity and filtering area within economical limits.

Catch-All® Application – Installation

TYPICAL PIPING DIAGRAM

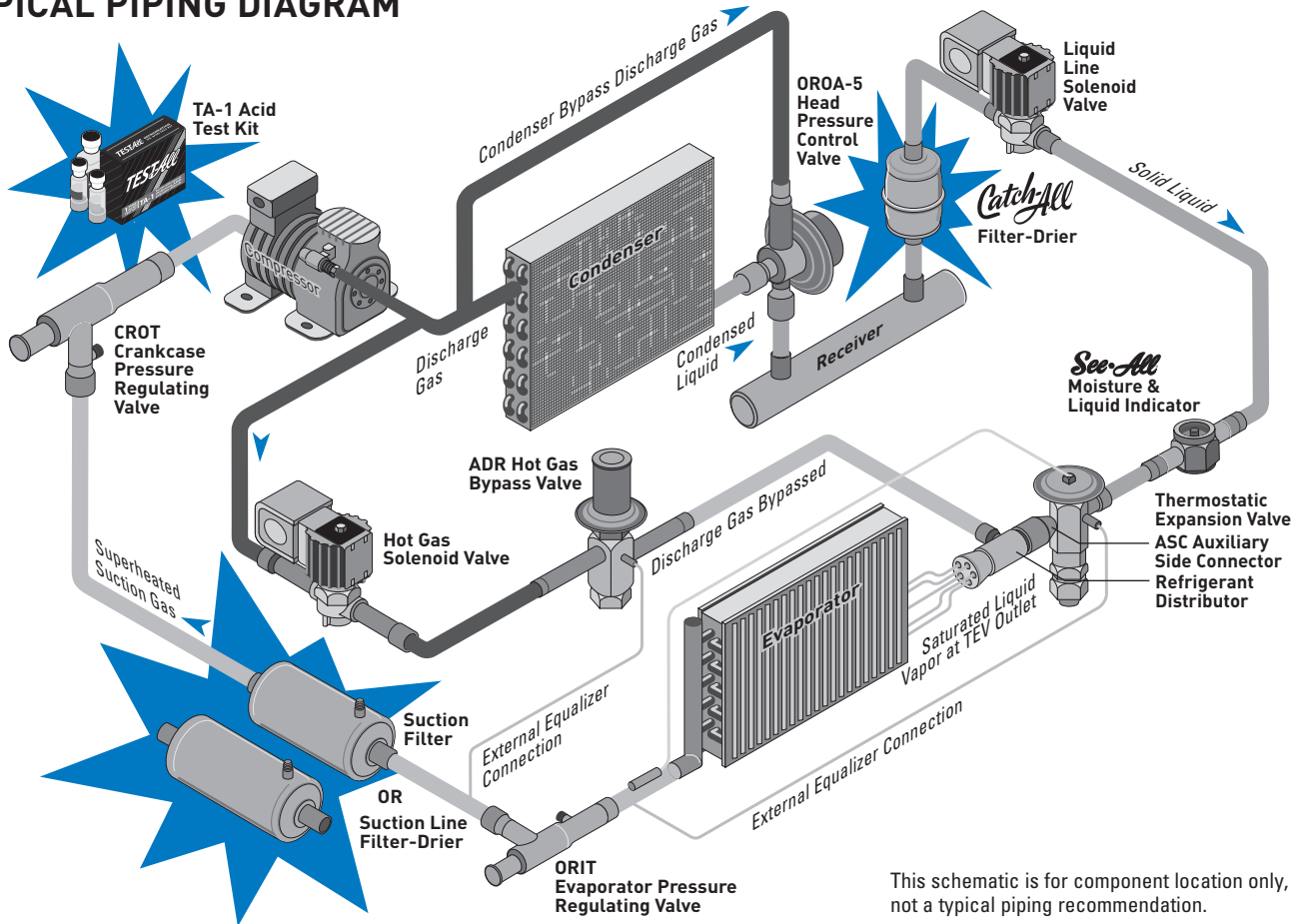

This schematic is for component location only, not a typical piping recommendation.

■ CATCH-ALL LOCATION

Catch-All Filter-Driers are most effective in the **liquid line**. Place the filter-drier immediately ahead of other liquid line controls, such as the thermostatic expansion valve, solenoid valve, and **See-All Moisture & Liquid Indicator**. When applied in this way, the Catch-All provides maximum protection for the expansion valve and solenoid valve from dirt that may be in the system. If the system contains appreciable moisture, then this location gives the best results in protecting the expansion valve from freeze-up. If possible, place the filter-drier in a **cold location**. The **acid removal ability** of the Catch-All Filter-Drier is the same whether it is installed in the liquid line or suction line.

Catch-All Filter-Driers are frequently installed in the **suction line** just ahead of

the compressor. This procedure is used to clean up a new system or a system that has had a hermetic motor burnout. The main advantage of this location is that it is directly ahead of the compressor, and therefore offers maximum protection to the compressor from all contaminants, even those that may be in the low side of the system. Suction line filter-driers give excellent performance in removing water, dirt and acid. A larger size filter-drier is required than if it had been placed in the liquid line. The refrigerant velocity in the suction line is about six times the velocity in the liquid line. Therefore, a larger filter-drier is required in order to maintain a sufficiently low pressure drop.

The **water capacity of a Sporlan Catch-All in the suction line** is equal to or slightly greater than the liquid line water capacity. Filtration and acid removal in the suction line is equal to that obtained

in the liquid line. The main disadvantage of the suction line location is that a larger more expensive filter-drier is required.

Catch-All Filter-Driers are not recommended for use in the **discharge line**. The water capacity in this location would be greatly reduced due to the high operating temperature.

Catch-All Filter-Driers may be installed in **any position**, with top or bottom feed. However, it is advisable to mount replaceable core models horizontally so that foreign material cannot drop into the outlet fitting when the cores are removed. Always observe the flow direction. Except for Catch-Alls used in heat pump systems (HPC models), Catch-Alls must **never** be subjected to reverse flow.

Catch-All Application – Installation

■ CAPILLARY TUBE SYSTEM

The C-032-CAP Catch-All is designed specifically for capillary tube systems. This unit consists of a C-032-S with 1/4" copper tubes brazed into each end, giving an overall length of 5.81"/148 mm. Capillary tubes of any size may be inserted into the 1/4" copper tube on this Catch-All, then the tubing pinched down, and soldered. In this way the excellent contaminant removal qualities of the Catch-All can be used on domestic refrigerators and freezers. The C-032-CAP-T model has an **access valve for charging purposes**.

The best filter-drier location is immediately ahead of the capillary tube. The **amount of liquid refrigerant** that the smaller size Catch-All Filter-Driers will contain at 100°F/38°C is shown in table below.

■ BYPASS INSTALLATION

It is preferred that the Catch-All Filter-Drier be installed in the **main liquid line** for maximum protection. When located in a bypass line, dirt or foreign material may pass into the system through the unprotected main line.

When a **bypass** installation is necessary (see illustration), a hand throttling valve **A** is recommended. By throttling valve **A**, a certain portion of refrigerant can be made to pass through the filter-drier. Note that hand valves **B** and **C** are required only if it is desired to replace the filter-drier without pumping down from the receiver. Always pump out the section of the line containing the filter-drier by closing hand

valves **A** and **B** (note direction of flow). Permit isolated section to pump out, close valve **C**, then change the **Catch-All Filter-Drier**.

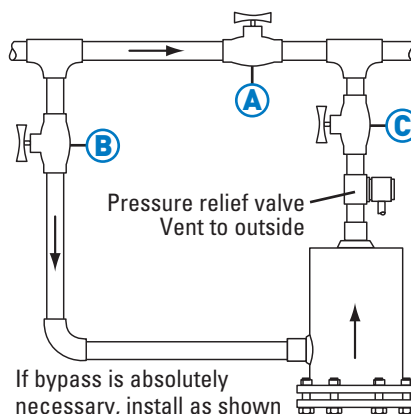

■ WARNING ■

Dangerous hydraulic pressures may develop if hand valves **B** and **C** are closed and the filter-drier is full of liquid. If there is a possibility of inexperienced personnel closing the valves without pumping down, a pressure relief device is recommended.

■ BRAZING AND SOLDERING

The solder fittings on sealed model and replaceable core Catch-All Filter-Driers are copper. Copper fittings are suitable for all types of brazing and soldering alloys including soft solder, 95-5 solder,

Sta-Brite solder, silver brazing alloy, Sil-Fos, or phos-copper alloys. The fittings on the Catch-All have been carefully cleaned and sealed before shipment, and do not require further cleaning before brazing. **Proper brazing technique involves using a wet cloth draped around the shell, and/or the use of Parker Virginia Thermal Block™, and proper torch tip for rapid heating, and also directing the flame away from the Catch-All shell.**

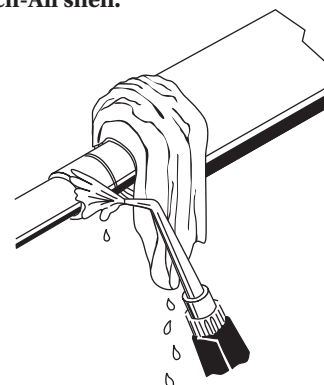

■ SEAL REMOVAL

The normal procedure in removing seals from either solder or flare connections is to gently cut them away with a knife, as shown in the illustration. With flare connections **caution** should be exercised to avoid damaging the flare surface. The seals cannot be removed and replaced without tearing them.

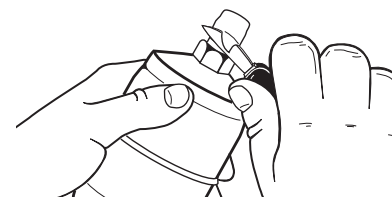

Catch-All Liquid Refrigerant Capacities

CATCH-ALL SERIES TYPE NO.	LIQUID CAPACITY													
	OUNCES OF REFRIGERANT BY WEIGHT AT 100°F							kg OF REFRIGERANT BY WEIGHT AT 38°C						
	REFRIGERANT							REFRIGERANT						
	22	134a	404A	407A/F	407C	410A	507	22	134a	404A	407A/F	407C	410A	507
C-030	1.4	1.4	1.1	1.3	1.2	1.2	1.2	0.04	0.04	0.03	0.04	0.03	0.03	0.03
C-050	3.4	3.4	2.8	3.2	3.0	3.0	2.9	0.10	0.10	0.08	0.09	0.08	0.08	0.08
C-080	5.2	5.3	4.3	4.9	4.6	4.5	4.5	0.15	0.15	0.12	0.14	0.13	0.13	0.13
C-160	9	9.1	7.4	8.5	7.9	7.9	7.7	0.26	0.26	0.21	0.24	0.22	0.22	0.22
C-300	14	14.2	11.5	13.2	12.3	12.2	12.0	0.40	0.40	0.33	0.38	0.35	0.35	0.34
C-410	16	16.2	13.1	15.1	14.1	14.0	13.8	0.45	0.46	0.37	0.43	0.40	0.40	0.39
HPC-080	8.5	-	-	-	7.5	7.4	-	0.24	-	-	-	0.21	0.21	-
HPC-100	8.7	-	-	-	7.7	7.6	-	0.25	-	-	-	0.22	0.22	-
HPC-160	11	-	-	-	9.7	9.6	-	0.31	-	-	-	0.27	0.27	-
HPC-300	17	-	-	-	15.0	14.9	-	0.48	-	-	-	0.42	0.42	-

Catch-All® Sealed Type Specifications



Type C-032 through C-609-S-T-HH
Maximum Rated Pressure of 650 psi

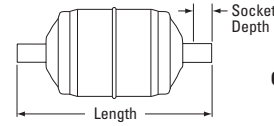
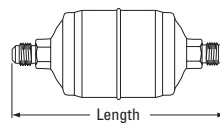

Liquid Line and Suction Line

Inches • lb

"C" SERIES LIQUID LINE TYPE		SUCTION LINE TYPE	CONNECTION SIZE Inches	VOLUME OF DESSICANT Cu. In.	OVERALL LENGTH Inches		SOLDER SOCKET DEPTH Inches	DIAMETER of BODY Inches	SHIPPING WEIGHT lb
SAE Flare	ODF Solder	ODF Solder			SAE Flare	ODF Solder			
C-032	C-032-S	—	1/4	3	4.24	3.78	0.37	1.75	1/2
—	C-032-CAP C-032-CAP-T	—	Extended 1/4 Male		—	5.78	—		
C-032-F	—	—	1/4 Male - Inlet 1/4 Female - Outlet		3.93	—	—		
C-032-FM	—	—	1/4 Female - Inlet 1/4 Male - Outlet		3.93	—	—		
C-033	C-033-S	—	3/8	5	4.68	3.92	0.44	2.44	3/4
C-052	C-052-S	—	1/4		4.72	4.26	0.37		
—	C-0525-S	—	5/16		—	4.40	0.44		
C-052-F	—	—	1/4 Male - Inlet 1/4 Female - Outlet		4.41	—	—		
C-052-FM	—	—	1/4 Female - Inlet 1/4 Male - Outlet	4.41	—	—			
C-053	C-053-S	—	3/8	9	5.16	4.40	0.44	2.62	1-1/4
C-082	C-082-S	—	1/4		5.62	5.16	0.38		
—	C-0825-S	—	5/16		—	5.30	0.44		
C-083	C-083-S	C-083-S-T-HH	3/8		6.06	5.30	0.44		
C-084	C-084-S	C-084-S-T-HH	1/2	6.32	5.42	0.50			
C-162	C-162-S	—	1/4	16	6.28	5.82	0.38	3.00	1-3/4
—	C-1625-S	—	5/16		—	5.96	0.44		
C-163	C-163-S	—	3/8		6.72	5.96	0.44		
C-164	C-164-S	C-164-S-T-HH	1/2		6.98	6.08	0.50		
C-165	C-165-S	C-165-S-T-HH	5/8		7.28	6.32	0.62		
—	—	C-166-S-T-HH	3/4		—	6.77	0.62		
—	C-167-S	C-167-S-T-HH	7/8	—	6.92	0.75			
C-303	C-303-S	—	3/8	30	9.62	8.86	0.44	3.00	3-1/2
C-304	C-304-S	—	1/2		9.88	8.98	0.50		
C-305	C-305-S	C-305-S-T-HH	5/8		10.18	9.22	0.62		
—	C-306-S	C-306-S-T-HH	3/4		—	9.67	0.62		
—	C-307-S	C-307-S-T-HH	7/8		—	9.82	0.75		
—	C-309-S	C-309-S-T-HH	1-1/8		—	9.77	0.91		
C-413	—	—	3/8	41	9.61	—	—	3.50	4-1/2
C-414	C-414-S	—	1/2		9.88	8.98	0.50		
C-415	C-415-S	—	5/8		10.18	9.22	0.62		
—	C-417-S	C-417-S-T-HH	7/8		—	9.82	0.75		
—	C-419-S	C-419-S-T-HH	1-1/8		—	9.77	0.91		
—	—	C-437-S-T-HH	7/8		—	10.34	0.75		
—	—	C-439-S-T-HH	1-1/8	—	10.74	0.91			
—	—	C-4311-S-T-HH	1-3/8	—	10.94	0.97			
—	—	C-4313-S-T-HH	1-5/8	—	10.94	1.09			
—	C-607-S	C-607-S-T-HH	7/8	60	—	15.93	0.75	3.00	6
—	C-609-S	C-609-S-T-HH	1-1/8		—	15.85	0.91		

cUL_{US} Listed — Guide-SMGT-File No. SA-1756A & B.

SIGNIFICANCE OF THE TYPE NUMBER

The letters and numerals in the Catch-All type number each have a significance.

- C** indicates Catch-All.
- FIRST TWO DIGITS** indicate the cubic inches of desiccant in the given drier size.
- LAST ONE OR TWO DIGITS** indicates the fitting size in eighths of an inch. For example: a "3" indicates 3/8" fitting size; a "25" indicates a 5/16" fitting size.
- NO LETTER** following the last digit indicates an SAE flare fitting.
- S** following the last digit indicates an ODF solder fitting. Other suffix letters indicate special qualities. Examples:
 - T** indicates a pressure tap consisting of a Schrader type access valve on the inlet end of the Catch-All.
 - HH** indicates a charcoal style core for wax removal and clean-up after a hermetic motor burnout.
 - F** indicates a female flare outlet fitting with a male flare inlet fitting.
- FM** indicates a female flare inlet fitting with a male flare outlet fitting.
- CAP** indicates a Catch-All particularly designed for installation on capillary tube systems. The fittings (a 1/4" OD copper tube brazed into each end of the Catch-All) permit inserting the capillary tube into this 1/4" tube, pinching down, and soldering to make the connections.

See page 6 for a description of construction details

Catch-All[®] Sealed Type Specifications



Type C-032 through C-609-S-T-HH
Maximum Rated Pressure of 44.8 bar

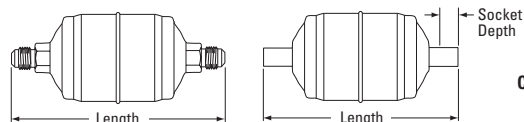

Liquid Line and Suction Line

mm • kg

"C" SERIES LIQUID LINE TYPE		SUCTION LINE TYPE	CONNECTION SIZE Inches	VOLUME OF DESSICANT cm ³	OVERALL LENGTH mm		SOLDER SOCKET DEPTH mm	DIAMETER of BODY mm	SHIPPING WEIGHT kg
SAE Flare	ODF Solder	ODF Solder			SAE Flare	ODF Solder			
C-032	C-032-S	—	1/4	49	108	96	9	44	0.2
—	C-032-CAP C-032-CAP-T	—	Extended 1/4 Male		—	147	—		
C-032-F	—	—	1/4 Male - Inlet 1/4 Female - Outlet		100	—	—		
C-032-FM	—	—	1/4 Female - Inlet 1/4 Male - Outlet		100	—	—		
C-033	C-033-S	—	3/8		119	100	11		
C-052	C-052-S	—	1/4	82	120	108	9	62	0.3
—	C-0525-S	—	5/16		—	112	11		
C-052-F	—	—	1/4 Male - Inlet 1/4 Female - Outlet		112	—	—		
C-052-FM	—	—	1/4 Female - Inlet 1/4 Male - Outlet		112	—	—		
C-053	C-053-S	—	3/8		131	112	11		
C-082	C-082-S	—	1/4	147	143	131	10	67	0.6
—	C-0825-S	—	5/16		—	135	11		
C-083	C-083-S	C-083-S-T-HH	3/8		154	135	11		
C-084	C-084-S	C-084-S-T-HH	1/2		161	138	13		
C-162	C-162-S	—	1/4		160	148	10		
—	C-1625-S	—	5/16	—	151	11	76	0.8	
C-163	C-163-S	—	3/8	171	151	11			
C-164	C-164-S	C-164-S-T-HH	1/2	177	154	13			
C-165	C-165-S	C-165-S-T-HH	5/8	185	161	16			
—	—	C-166-S-T-HH	3/4	—	172	16			
—	C-167-S	C-167-S-T-HH	7/8	—	176	19	76	1.6	
C-303	C-303-S	—	3/8	246	225	11			
C-304	C-304-S	—	1/2	251	228	13			
C-305	C-305-S	C-305-S-T-HH	5/8	259	234	16			
—	C-306-S	C-306-S-T-HH	3/4	—	246	16			
—	C-307-S	C-307-S-T-HH	7/8	—	249	19	89	2.1	
—	C-309-S	C-309-S-T-HH	1-1/8	—	248	23			
C-413	—	—	3/8	244	—	—			
C-414	C-414-S	—	1/2	251	230	13			
C-415	C-415-S	—	5/8	259	237	16			
—	C-417-S	C-417-S-T-HH	7/8	—	249	19	121	3.6	
—	C-419-S	C-419-S-T-HH	1-1/8	—	248	23			
—	—	C-437-S-T-HH	7/8	—	263	19			
—	—	C-439-S-T-HH	1-1/8	—	273	23			
—	—	C-4311-S-T-HH	1-3/8	—	278	25			
—	—	C-4313-S-T-HH	1-5/8	—	278	28	76	2.7	
—	C-607-S	C-607-S-T-HH	7/8	—	405	19			
—	C-609-S	C-609-S-T-HH	1-1/8	—	403	23			

cUL_{us} Listed — Guide-SMGT-File No. SA-1756A & B.



Liquid Line

Ratings and Selection Recommendations

Sealed Type – Refrigerant 134a



134a

TYPE	SURFACE FILTERING AREA		RATINGS AT AHRI STANDARD CONDITIONS				SELECTION RECOMMENDATIONS (Tons)		
			WATER CAPACITY DROPS AT 60 PPM		REFRIGERANT FLOW CAPACITY		REFRIGERATION Commercial & Low Temperature Equipment	AIR CONDITIONING	
	Sq. Inch	cm ²	75°F 25°C	125°F 50°C	Tons at 1 psi ΔP	kW at 0.07 bar ΔP		O.E.M. Self Contained	Field Replacement or Field Built-Up Systems
C-032	9	58	67	48	1.3	4.6	1/4	3/4	1/2
C-032-CAP									
C-032-S									
C-032-F					3.2	11.2			
C-032-FM									
C-033									
C-033-S	3.5	12.3							
C-052	15	97	158	114	1.9	6.7	1/3	1 thru 2	3/4 thru 1
C-052-S									
C-052-F									
C-052-FM					3.1	10.9			
C-0525-S									
C-053									
C-053-S	3.8	13.3							
C-082	21	135	261	188	1.9	6.7	1/2 thru 1-1/2	1 thru 4	3/4 thru 2
C-082-S									
C-0825-S									
C-083					4.2	14.7			
C-083-S									
C-084									
C-084-S	7.4	26.0							
C-162	33	213	396	285	1.9	6.7	1 thru 2	2 thru 7-1/2	1 thru 5
C-162-S									
C-1625-S									
C-163					4.2	14.7			
C-163-S									
C-164									
C-164-S	9.3	32.6							
C-165	10.1	35.5							
C-165-S	11.0	38.6							
C-303	53	342	756	545	4.2	14.7	3 thru 5	4 thru 15	3 thru 7-1/2
C-303-S									
C-304									
C-304-S					10.1	35.5			
C-305									
C-305-S									
C-307-S	13.6	47.7							
C-414	67	432	1017	733	15.5	54.4	5 thru 10	7-1/2 thru 18	5 thru 12
C-414-S									
C-415									
C-415-S					10.5	36.9			
C-417-S									
C-419-S									
C-419-S	11.4	40.0							
C-607-S	106	684	1512	1090	22.3	78.3	15	20 thru 25	15
C-609-S									
C-609-S					30.4	106.7			

For suction line filter-driers see page 34

NOTES: The variation in flow ratings of filter-driers having the same size core and shell is caused by the difference in connection sizes used.



Liquid Line

Ratings and Selection Recommendations

Sealed Type – Refrigerant 22

TYPE	SURFACE FILTERING AREA		RATINGS AT AHRI STANDARD CONDITIONS				SELECTION RECOMMENDATIONS (Tons)		
			WATER CAPACITY DROPS AT 50 PPM		REFRIGERANT FLOW CAPACITY		REFRIGERATION Commercial & Low Temperature Equipment	AIR CONDITIONING	
	Sq. Inch	cm ²	75°F 25°C	125°F 50°C	Tons at 1 psi ΔP	kW at 0.07 bar ΔP		O.E.M. Self Contained	Field Replacement or Field Built-Up Systems
C-032	9	58	61	50	1.5	5.3	1/4	1	1/2
C-032-CAP									
C-032-S									
C-032-F					3.5	12.3			
C-032-FM									
C-033									
C-033-S	3.8	13.3							
C-052	15	97	146	119	2.1	7.4	1/3	1 thru 3	3/4 thru 2
C-052-S									
C-052-F									
C-052-FM					3.4	11.9			
C-0525-S									
C-053									
C-053-S	4.1	14.4							
C-082	21	135	240	196	2.1	7.4	1/2 thru 1-1/2	1 thru 5	1 thru 2
C-082-S									
C-0825-S									
C-083					4.5	15.8			
C-083-S									
C-084									
C-084-S	8.1	28.4							
C-162	33	213	364	297	2.1	7.4	1-1/2 thru 3	2 thru 10	1-1/2 thru 5
C-162-S									
C-1625-S									
C-163					4.5	15.8			
C-163-S									
C-164									
C-164-S	10.1	35.5							
C-165	11.0	38.6							
C-165-S	12.1	42.5							
C-303	53	342	696	567	4.6	16.1	3 thru 5	5 thru 15	4 thru 10
C-303-S									
C-304									
C-304-S					11.0	38.6			
C-305									
C-305-S									
C-307-S	14.9	52.3							
C-414	67	432	936	763	21.6	75.8	5 thru 12	7-1/2 thru 23	7-1/2 thru 15
C-414-S									
C-415									
C-415-S					11.5	40.4			
C-417-S									
C-419-S									
C-607-S	106	684	1392	1134	17.5	61.4	15	25 thru 30	20
C-609-S					22.1	77.6			
					24.3	85.3			
					29.1	102.1			
					33.2	116.5			



22

For suction line
filter-driers
see page 34

NOTES: The variation in flow ratings of filter-driers having the same size core and shell is caused by the difference in connection sizes used.



Liquid Line

Ratings and Selection Recommendations

Sealed Type – Refrigerant 404A & 507



404A & 507

TYPE	SURFACE FILTERING AREA		RATINGS AT AHRI STANDARD CONDITIONS				SELECTION RECOMMENDATIONS (Tons)		
	Sq. Inch	cm ²	WATER CAPACITY DROPS AT 50 PPM		REFRIGERANT FLOW CAPACITY		REFRIGERATION Commercial & Low Temperature Equipment	AIR CONDITIONING	
			75°F 25°C	125°F 50°C	Tons at 1 psi ΔP	kW at 0.07 bar ΔP		O.E.M. Self Contained	Field Replacement or Field Built-Up Systems
C-032	9	58	71	58	1.0	3.5	1/4	3/4	1/2
C-032-CAP									
C-032-S									
C-032-F					2.3	8.1			
C-032-FM									
C-033									
C-033-S	2.6	9.1							
C-052	15	97	169	138	1.4	4.9	1/3	1 thru 2	3/4 thru 1
C-052-S									
C-052-F									
C-052-FM					2.3	8.1			
C-0525-S									
C-053									
C-053-S	2.7	9.5							
C-082	21	135	279	227	1.4	4.9	1/2 thru 1	1 thru 4	3/4 thru 2
C-082-S									
C-0825-S									
C-083									
C-083-S									
C-084					5.5	19.3			
C-084-S									
C-162									
C-162-S	33	213	424	345	1.4	4.9	3/4 thru 2	2 thru 7-1/2	1 thru 4
C-1625-S									
C-163									
C-163-S									
C-164									
C-164-S					6.8	23.9			
C-165									
C-165-S									
C-303	53	342	809	658	3.0	10.5	2 thru 5	4 thru 12	3 thru 7-1/2
C-303-S									
C-304									
C-304-S									
C-305									
C-305-S					9.9	34.7			
C-307-S									
C-414									
C-414-S	67	432	1088	885	7.6	26.7	5 thru 10	5 thru 15	5 thru 12
C-415									
C-415-S									
C-417-S									
C-419-S									
C-419-S					11.8	41.4			
C-607-S									
C-609-S									
C-607-S	106	684	1618	1316	29.5	103.5	10	15 thru 20	10
C-609-S					22.3	78.3			

For suction line filter-driers see page 34

NOTE: The variation in flow ratings of filter-driers having the same size core and shell is caused by the difference in connection sizes used. R-502 water capacities are similar to R-404A and R-507.



Liquid Line

Ratings and Selection Recommendations

Sealed Type – Refrigerant 407C

TYPE	SURFACE FILTERING AREA		RATINGS AT AHRI STANDARD CONDITIONS				SELECTION RECOMMENDATIONS (Tons)		
	Sq. Inch	cm ²	WATER CAPACITY DROPS AT 50 PPM		REFRIGERANT FLOW CAPACITY		REFRIGERATION Commercial & Low Temperature Equipment	AIR CONDITIONING	
			75°F 25°C	125°F 50°C	Tons at 1 psi ΔP	kW at 0.07 bar ΔP		O.E.M. Self Contained	Field Replacement or Field Built-Up Systems
C-032	9	58	52	17	1.3	4.6	1/4	1	1/2
C-032-CAP									
C-032-S									
C-032-F					3.2	11.2			
C-032-FM									
C-033									
C-033-S	3.5	12.3	1/3	1 thru 3	3/4 thru 2				
C-052	15	97				123	40	1.9	6.7
C-052-S									
C-052-F									
C-052-FM								3.1	10.9
C-0525-S									
C-053									
C-053-S	3.8	13.3	1/2 thru 1-1/2	1 thru 5	1 thru 2				
C-082	21	135				202	65	1.9	6.7
C-082-S									
C-0825-S									
C-083								4.2	14.7
C-083-S									
C-084									
C-084-S	7.5	26.3	1-1/2 thru 3	2 thru 10	1-1/2 thru 5				
C-162	33	213				307	100	1.9	6.7
C-162-S									
C-1625-S									
C-163								4.2	14.7
C-163-S									
C-164									
C-164-S	9.3	32.6	3 thru 5	5 thru 20	4 thru 10				
C-165	10.1	35.5							
C-165-S									
C-303									
C-303-S	11.1	39.0				5 thru 12	7-1/2 thru 23	7-1/2 thru 15	
C-304	4.2	14.7							
C-304-S									
C-305									
C-305-S	13.7	48.1	15	25 thru 30	20				
C-307-S	15.5	54.4							
C-414									
C-414-S									
C-415	10.5	36.9							
C-415-S									
C-417-S									
C-419-S	11.4	40.0	26.8	94.1	30.7				
C-607-S	14.6	51.2							
C-609-S									
	16.2	56.9							
	20.4	71.6							
	22.4	78.6							
	26.8	94.1							
	30.7	107.8							



407C

For suction line filter-driers see page 34

NOTE: The variation in flow ratings of filter-driers having the same size core and shell is caused by the difference in connection sizes used.

Catch-All® Liquid Line Ratings and Selection Recommendations

Sealed Type – Refrigerant 407A



407A

TYPE	SURFACE FILTERING AREA		RATINGS AT AHRI STANDARD CONDITIONS				SELECTION RECOMMENDATIONS (Tons)		
			WATER CAPACITY DROPS AT 50 PPM		REFRIGERANT FLOW CAPACITY		REFRIGERATION Commercial & Low Temperature Equipment	AIR CONDITIONING	
	Sq. Inch	cm ²	75°F 25°C	125°F 50°C	Tons at 1 psi ΔP	kW at 0.07 bar ΔP		O.E.M. Self Contained	Field Replacement or Field Built-Up Systems
C-032	9	58	37	27	1.3	4.4	1/4	1	1/2
C-032-CAP									
C-032-S									
C-032-F									
C-032-FM									
C-033					3.0	10.7			
C-033-S	3.3	11.7							
C-052	15	97	98	72	1.8	6.3	1/3	1 thru 3	3/4 thru 2
C-052-S									
C-052-F									
C-052-FM									
C-0525-S					2.8	9.8			
C-053					3.6	12.6			
C-053-S	4.1	14.3							
C-082	21	135	145	107	1.8	6.3	1/2 thru 1-1/2	1 thru 5	1 thru 2
C-082-S									
C-0825-S									
C-083					3.9	13.8			
C-083-S					4.5	15.8			
C-084					6.6	23.3			
C-084-S	7.6	26.6							
C-162	33	213	216	159	1.8	6.3	1-1/2 thru 3	2 thru 10	1-1/2 thru 5
C-162-S									
C-1625-S									
C-163					3.9	13.8			
C-163-S					4.5	15.8			
C-164					8.8	30.9			
C-164-S					9.6	33.6			
C-165					10.5	36.9			
C-165-S	12.1	42.5							
C-303	53	342	430	317	4.0	13.9	3 thru 5	5 thru 20	4 thru 10
C-303-S									
C-304									
C-304-S					9.6	33.6			
C-305					12.9	45.3			
C-305-S					14.7	51.6			
C-307-S	18.8	66.0							
C-414	67	432	598	440	10.0	35.0	5 thru 12	7-1/2 thru 23	7-1/2 thru 15
C-414-S									
C-415									
C-415-S					13.8	48.4			
C-417-S					15.3	53.7			
C-419-S					19.3	67.7			
C-419-S	21.2	74.4							
C-607-S	106	684	970	713	25.3	88.8	15	25 thru 30	20
C-609-S					28.9	101.4			

For suction line filter-driers see page 34

NOTE: The variation in flow ratings of filter-driers having the same size core and shell is caused by the difference in connection sizes used.



Liquid Line

Ratings and Selection Recommendations

Sealed Type – Refrigerant 407F

TYPE	SURFACE FILTERING AREA		RATINGS AT AHRI STANDARD CONDITIONS				SELECTION RECOMMENDATIONS (Tons)				
	Sq. Inch	cm ²	WATER CAPACITY DROPS AT 50 PPM		REFRIGERANT FLOW CAPACITY		REFRIGERATION Commercial & Low Temperature Equipment	AIR CONDITIONING			
			75°F 25°C	125°F 50°C	Tons at 1 psi ΔP	kW at 0.07 bar ΔP		O.E.M. Self Contained	Field Replacement or Field Built-Up Systems		
C-032	9	58	24	18	1.4	4.9	1/4	1	1/2		
C-032-CAP											
C-032-S											
C-032-F											
C-032-FM											
C-033											
C-033-S	3.4	11.8									
C-052	15	97	65	48	2.0	6.9	1/3	1 thru 3	3/4 thru 2		
C-052-S											
C-052-F											
C-052-FM											
C-0525-S										3.3	11.4
C-053										4.0	13.9
C-053-S	4.5	15.7									
C-082	21	135	96	71	2.0	6.9	1/2 thru 1-1/2	1 thru 5	1 thru 2		
C-082-S											
C-0825-S										3.6	12.5
C-083										4.3	15.2
C-083-S										5.0	17.4
C-084										7.8	27.2
C-084-S	9.2	32.4									
C-162	33	213	143	106	2.0	6.9	1-1/2 thru 3	2 thru 10	1-1/2 thru 5		
C-162-S											
C-1625-S										3.6	12.5
C-163										4.3	15.2
C-163-S										5.0	17.4
C-164										9.7	34.0
C-164-S	10.5	36.9									
C-165	13.2	46.3									
C-165-S	15.2	53.4									
C-303	53	342	284	211	4.4	15.3	3 thru 5	5 thru 20	4 thru 10		
C-303-S											
C-304										9.7	34.0
C-304-S										10.5	36.9
C-305										14.2	49.8
C-305-S										16.2	56.9
C-307-S	20.7	72.7									
C-414	67	432	395	293	11.0	38.6	5 thru 12	7-1/2 thru 23	7-1/2 thru 15		
C-414-S											
C-415										11.9	41.8
C-415-S										15.2	53.4
C-415-S										16.8	59.0
C-417-S										21.2	74.4
C-419-S	23.4	82.1									
C-607-S	106	684	640	476	27.9	97.9	15	25 thru 30	20		
C-609-S					31.9	112.0					



407F

For suction line filter-driers see page 34

NOTE: The variation in flow ratings of filter-driers having the same size core and shell is caused by the difference in connection sizes used.



Liquid Line

Ratings and Selection Recommendations

Sealed Type – Refrigerant 410A



410A

TYPE	SURFACE FILTERING AREA		RATINGS AT AHRI STANDARD CONDITIONS				SELECTION RECOMMENDATIONS (Tons)				
			WATER CAPACITY DROPS AT 50 PPM		REFRIGERANT FLOW CAPACITY		REFRIGERATION Commercial & Low Temperature Equipment	AIR CONDITIONING			
	Sq. Inch	cm ²	75°F 25°C	125°F 50°C	Tons at 1 psi ΔP	kW at 0.07 bar ΔP		O.E.M. Self Contained	Field Replacement or Field Built-Up Systems		
C-032	9	58	27	20	1.4	4.9	1/4	1	1/2		
C-032-CAP											
C-032-S											
C-032-F											
C-032-FM											
C-033					3.4	11.9					
C-033-S	3.7	13.0									
C-052	15	97	63	48	2.0	7.0	1/3	1 thru 3	3/4 thru 2		
C-052-S											
C-052-F											
C-052-FM											
C-0525-S					3.3	11.6					
C-053					4.0	14.0					
C-053-S	4.5	15.8									
C-082	21	135	104	78	2.0	7.0	1/2 thru 1-1/2	1 thru 5	1 thru 2		
C-082-S											
C-0825-S										3.5	12.3
C-083					4.4	15.4					
C-083-S					5.0	17.6					
C-084					7.9	27.7					
C-084-S	8.5	29.8									
C-162	33	213	158	119	2.0	7.0	1-1/2 thru 3	2 thru 10	1-1/2 thru 5		
C-162-S											
C-1625-S										3.5	12.3
C-163					4.4	15.4					
C-163-S					5.0	17.6					
C-164					9.8	34.4					
C-164-S	10.7	37.6									
C-165	53	342	302	227	11.7	41.1	3 thru 5	5 thru 20	4 thru 10		
C-165-S										13.4	47.0
C-303										4.4	15.4
C-303-S					5.0	17.6					
C-304					9.8	34.4					
C-304-S					10.7	37.6					
C-305	14.5	50.9									
C-305-S	16.4	57.6									
C-307-S	21.0	73.7									
C-414	67	432	407	305	11.1	39.0	5 thru 12	7-1/2 thru 23	7-1/2 thru 15		
C-414-S										12.1	42.5
C-415										15.4	54.1
C-415-S					17.1	60.0					
C-417-S					21.5	75.5					
C-419-S					23.7	83.2					
C-607-S	106	684	604	454	28.4	99.7	15	25 thru 30	20		
C-609-S					32.4	113.7					

For suction line filter-driers see page 34

NOTE: The variation in flow ratings of filter-driers having the same size core and shell is caused by the difference in connection sizes used.



Liquid Line

Reversible Heat Pump Filter-Driers



Type HPC-082 through HPC-307-S-HH
Maximum Rated Pressure of 650 psi / 44.8 bar

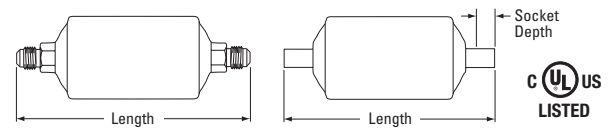

DESIGN FEATURES:

- Enhanced flow capacities deliver system protection solutions for today's system sizes.
- Filter-drier operates in either flow direction with low pressure drop.
- Sporlan dependable molded core for maximum filtration ability. When flow reverses, dirt already collected remains in the filter-drier.
- Rugged metal check valve designed for maximum flow capacity.
- Catch-All shells are epoxy powder coated to prevent corrosion even in the most adverse conditions.
- Carefully engineered desiccant formulations for new system and system clean-up for all commercially available HCFC and HFC refrigerant/lubricant combinations.
- HPC-160 and HPC-300 Series incorporate the largest core size available in the industry per filter-drier type. A larger molded core provides superior performance, and is especially advantageous for R-410A/POE lubricant systems.
- Shells listed by Underwriters Laboratories for 650 psi for R-410A systems.

Specifications

Inches • lb

"HPC" SERIES LIQUID LINE TYPE		CONNECTION SIZE Inches	VOLUME OF DESSICANT Cu. In.	OVERALL LENGTH Inches		SOLDER SOCKET DEPTH Inches	DIAMETER of BODY Inches	SHIPPING WEIGHT lb
SAE Flare	ODF Solder			SAE Flare	ODF Solder			
HPC-082	HPC-082-S	1/4	8	5.78	5.32	.38	3.0	1-1/4
HPC-083	HPC-083-S	3/8		6.22	5.46	.44		
HPC-084	HPC-084-S	1/2		6.48	5.58	.50		
HPC-103	HPC-103-S	3/8	10	6.72	5.96	.44	3.0	1-3/4
HPC-104	HPC-104-S	1/2		6.98	6.08	.50		
HPC-105	HPC-105-S	5/8		7.28	6.32	.62		
HPC-163	HPC-163-S	3/8	14	7.78	6.92	.44	3.0	2-1/4
HPC-163-HH	HPC-163-S-HH	3/8		7.78	6.92	.44		
HPC-164	HPC-164-S	1/2		7.95	7.07	.50		
HPC-164-HH	HPC-164-S-HH	1/2		7.95	7.07	.50		
HPC-165	HPC-165-S	5/8		8.28	7.35	.62		
HPC-165-HH	HPC-165-S-HH	5/8		8.28	7.35	.62		
HPC-304	HPC-304-S	1/2	30	11.08	10.18	.50	3.0	4-1/4
HPC-304-HH	HPC-304-S-HH	1/2		11.08	10.18	.50		
HPC-305	HPC-305-S	5/8		11.38	10.42	.62		
HPC-305-HH	HPC-305-S-HH	5/8		11.38	10.42	.62		
—	HPC-306-S	3/4		—	10.86	.62		
—	HPC-307-S	7/8		—	11.02	.75		
—	HPC-307-S-HH	7/8	—	11.02	.75			

Consult Sporlan Division for applications not in liquid line.

Specifications

mm • kg

"HPC" SERIES LIQUID LINE TYPE		CONNECTION SIZE Inches	VOLUME OF DESSICANT cm ³	OVERALL LENGTH mm		SOLDER SOCKET DEPTH mm	DIAMETER of BODY mm	SHIPPING WEIGHT kg
SAE Flare	ODF Solder			SAE Flare	ODF Solder			
HPC-082	HPC-082-S	1/4	131	147	135	10	76	0.6
HPC-083	HPC-083-S	3/8		158	139	11		
HPC-084	HPC-084-S	1/2		165	142	13		
HPC-103	HPC-103-S	3/8	164	171	151	11	76	0.8
HPC-104	HPC-104-S	1/2		177	154	13		
HPC-105	HPC-105-S	5/8		185	161	16		
HPC-163	HPC-163-S	3/8	229	198	176	11	76	1.0
HPC-163-HH	HPC-163-S-HH	3/8		198	176	11		
HPC-164	HPC-164-S	1/2		202	180	13		
HPC-164-HH	HPC-164-S-HH	1/2		202	180	13		
HPC-165	HPC-165-S	5/8		210	187	16		
HPC-165-HH	HPC-165-S-HH	5/8		210	187	16		
HPC-304	HPC-304-S	1/2	492	281	259	13	76	1.9
HPC-304-HH	HPC-304-S-HH	1/2		281	259	13		
HPC-305	HPC-305-S	5/8		289	265	16		
HPC-305-HH	HPC-305-S-HH	5/8		289	265	16		
—	HPC-306-S	3/4		—	276	16		
—	HPC-307-S	7/8		—	280	19		
—	HPC-307-S-HH	7/8	—	280	19			



Liquid Line Reversible Heat Pump Filter-Driers

Ratings and Selection Recommendations

For New Installations – Refrigerant 22



22

TYPE	SURFACE FILTERING AREA		RATINGS AT AHRI STANDARD CONDITIONS				SELECTION RECOMMENDATIONS (Tons)						
			WATER CAPACITY DROPS AT 60 PPM		REFRIGERANT FLOW CAPACITY		AIR CONDITIONING						
	Sq. Inch	cm ²	75°F 25°C	125°F 50°C	Tons at 1 psi ΔP	kW at 0.07 bar ΔP							
HPC-082	15	97	194	158	2.2	7.7	1 thru 3						
HPC-082-S					3.7	13.0							
HPC-083								4.1	14.4				
HPC-083-S										5.0	17.6		
HPC-084													
HPC-084-S	18	116	215	176	5.5	19.3	1 thru 5						
HPC-103					8.3	29.1							
HPC-103-S								8.9	31.2				
HPC-104										10.2	35.8		
HPC-104-S												10.8	37.9
HPC-105													
HPC-105-S	26	168	364	297	5.0	17.6	1 thru 8						
HPC-163					5.5	19.3							
HPC-163-S								8.3	29.1				
HPC-164										8.9	31.2		
HPC-164-S													
HPC-165	10.2	35.8											
HPC-165-S			10.8	37.9									
HPC-304					53	342	696	567	8.7	30.5	8 thru 20		
HPC-304-S	9.3	32.6											
HPC-305			9.9	34.7									
HPC-305-S									10.5	36.9			
HPC-306-S												11.0	38.6
HPC-307-S													

For Clean-Up After Burnout – Refrigerant 22

TYPE	SURFACE FILTERING AREA		RATINGS AT AHRI STANDARD CONDITIONS				SELECTION RECOMMENDATIONS (Tons)						
			WATER CAPACITY DROPS AT 60 PPM		REFRIGERANT FLOW CAPACITY		AIR CONDITIONING						
	Sq. Inch	cm ²	75°F 25°C	125°F 50°C	Tons at 1 psi ΔP	kW at 0.07 bar ΔP							
HPC-163-HH	26	168	93	81	4.8	16.8	1 thru 8						
HPC-163-S-HH					5.2	18.3							
HPC-164-HH								7.9	27.7				
HPC-164-S-HH										8.5	29.8		
HPC-165-HH												9.7	34.0
HPC-165-S-HH													
HPC-304-HH	53	342	167	119	8.3	29.1	8 thru 20						
HPC-304-S-HH					8.8	30.9							
HPC-305-HH								9.4	33.0				
HPC-305-S-HH										10.8	37.9		
HPC-307-S-HH												10.8	37.9



Liquid Line Reversible Heat Pump Filter-Driers

Ratings and Selection Recommendations

For New Installations – Refrigerant 407C

TYPE	SURFACE FILTERING AREA		RATINGS AT AHRI STANDARD CONDITIONS				SELECTION RECOMMENDATIONS (Tons)				
			WATER CAPACITY DROPS AT 50 PPM		REFRIGERANT FLOW CAPACITY		AIR CONDITIONING				
	Sq. Inch	cm ²	75°F 25°C	125°F 50°C	Tons at 1 psi ΔP	kW at 0.07 bar ΔP					
HPC-082	15	97	163	53	2.0	7.0	1 thru 3				
HPC-082-S					3.4	11.9					
HPC-083								3.8	13.3		
HPC-083-S											
HPC-084											
HPC-084-S											
HPC-103	18	116	181	80	4.6	16.1	1 thru 5				
HPC-103-S					5.1	17.9					
HPC-104								7.6	26.7		
HPC-104-S										8.2	28.8
HPC-105											
HPC-105-S	9.4	33.0									
HPC-163	26	168	307	100	4.6	16.1	1 thru 8				
HPC-163-S					5.1	17.9					
HPC-164								7.6	26.7		
HPC-164-S										8.2	28.8
HPC-165											
HPC-165-S	9.4	33.0									
HPC-304	53	342	586	189	8.0	28.1	8 thru 20				
HPC-304-S					8.6	30.2					
HPC-305								9.1	31.9		
HPC-305-S										9.7	34.0
HPC-306-S											
HPC-307-S	10.1	35.5									
					10.5	36.9					



407C

For Clean-Up After Burnout – Refrigerant 407C

TYPE	SURFACE FILTERING AREA		RATINGS AT AHRI STANDARD CONDITIONS				SELECTION RECOMMENDATIONS (Tons)				
			WATER CAPACITY DROPS AT 50 PPM		REFRIGERANT FLOW CAPACITY		AIR CONDITIONING				
	Sq. Inch	cm ²	75°F 25°C	125°F 50°C	Tons at 1 psi ΔP	kW at 0.07 bar ΔP					
HPC-163-HH	26	168	90	88	4.4	15.4	1 thru 8				
HPC-163-S-HH					4.8	16.8					
HPC-164-HH								7.3	25.6		
HPC-164-S-HH										7.8	27.4
HPC-165-HH											
HPC-165-S-HH	8.9	31.2									
HPC-304-HH	53	342	161	88	7.6	26.7	8 thru 20				
HPC-304-S-HH					8.1	28.4					
HPC-305-HH								8.6	30.2		
HPC-305-S-HH										9.2	32.3
HPC-307-S-HH											



Liquid Line Reversible Heat Pump Filter-Driers

Ratings and Selection Recommendations

For New Installations – Refrigerant 410A



410A

TYPE	SURFACE FILTERING AREA		RATINGS AT AHRI STANDARD CONDITIONS				SELECTION RECOMMENDATIONS (Tons)				
			WATER CAPACITY DROPS AT 50 PPM		REFRIGERANT FLOW CAPACITY		AIR CONDITIONING				
	Sq. Inch	cm ²	75°F 25°C	125°F 50°C	Tons at 1 psi ΔP	kW at 0.07 bar ΔP					
HPC-082	15	97	85	63	2.1	7.4	1 thru 3				
HPC-082-S					3.6	12.6					
HPC-083								4.0	14.0		
HPC-083-S										4.9	17.2
HPC-084											
HPC-084-S	18	116	94	70	5.4	19.0	1 thru 5				
HPC-103					8.1	28.4					
HPC-103-S								8.7	30.5		
HPC-104										10.0	35.1
HPC-104-S											
HPC-105	26	168	158	119	10.6	37.2	1 thru 8				
HPC-105-S					4.9	17.2					
HPC-163								5.4	19.0		
HPC-163-S										8.1	28.4
HPC-164											
HPC-164-S	53	342	302	227	8.7	30.5	8 thru 20				
HPC-165					10.0	35.1					
HPC-165-S								8.5	29.8		
HPC-304										9.1	31.9
HPC-304-S											
HPC-305	10.3	36.2									
HPC-305-S			9.7	34.0							
HPC-306-S					10.8	37.9					
HPC-307-S							11.2	39.3			
HPC-307-S											

For Clean-Up After Burnout – Refrigerant 410A

TYPE	SURFACE FILTERING AREA		RATINGS AT AHRI STANDARD CONDITIONS				SELECTION RECOMMENDATIONS (Tons)				
			WATER CAPACITY DROPS AT 50 PPM		REFRIGERANT FLOW CAPACITY		AIR CONDITIONING				
	Sq. Inch	cm ²	75°F 25°C	125°F 50°C	Tons at 1 psi ΔP	kW at 0.07 bar ΔP					
HPC-163-HH	26	168	69	100	4.7	16.5	1 thru 8				
HPC-163-S-HH					5.1	17.9					
HPC-164-HH								7.7	27.0		
HPC-164-S-HH										8.3	29.1
HPC-165-HH											
HPC-165-S-HH	53	342	123	109	9.5	33.3	8 thru 20				
HPC-304-HH					10.1	35.5					
HPC-304-S-HH								8.1	28.4		
HPC-305-HH										8.6	30.2
HPC-305-S-HH											
HPC-305-S-HH	9.2	32.3									
HPC-307-S-HH			9.8	34.4							
HPC-307-S-HH					10.6	37.2					

Catch-All® Replaceable Core Type

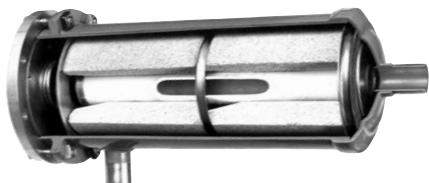

DESIGN FEATURES:

CONSTRUCTION

The Catch-All shell utilizes an **exclusive filter-within-a-filter construction**. The new internal assembly, when used with Sporlan molded cores, provides maximum water capacity, excellent acid removal characteristics, the ability to remove products of lubricant decomposition, and outstanding filtration. The **optional replaceable secondary filter** offers unsurpassed filtration efficiencies without compromising the Catch-All's ability to hold a large amount of foreign material. The assembly is designed so the cores remove larger sized particles while the secondary filter removes microscopic particles. This unique construction aggressively filters particles circulating in a refrigerant system. **This design is especially advantageous when commissioning a larger system.**

FLEXIBILITY

The shell design offers **flexibility**. The new internal assembly can be used with or without the secondary filter. The type of filtration needed depends upon the system requirements or application. Using the assembly **without** the secondary filter offers the same time tested, field-proven, filtration characteristics expected in a Catch-All Filter-Drier.

INTERNAL ASSEMBLY

The internal construction is designed to improve **ease of assembly**. The molded cores simply slide over the center tube, followed by spacer plates (if applicable). The outlet plate is fastened to the assembly by a wing screw. With the addition of a spring, the resulting assembly is easy to install and remove.

The seal gasket prevents solid contaminants from bypassing the filter. The assembly is held tight against the gasket by a spring. **O-rings** are used with the secondary filter to provide a tight seal.

The internal parts are plated steel – no plastic parts.

BOLT AND NUT ATTACHMENT

The **bolt and nut attachment** of the endplate allows for simple, trouble-free installation. The nuts lock against the side of the shell for ease in tightening. Other designs, using cap screws threaded into the flange ring, run the risk of twisting off the head of the screw making removal difficult.

FITTINGS

Copper fittings are excellent for fast easy soldering. Fittings are pre-sized for proper fit, and suitable for use with soft solder, silver solder, Sil-Fos, or Phos-Copper. The fittings are brazed to the shell with a high temperature brazing alloy so they never loosen during the brazing operation on the job.

A **complete line of fitting sizes** are available with solder connections from 1/2" to 4-1/8" ODF and pipe connections from 1/2" to 2".

SHELLS

Heavy steel shells provide **high bursting strength** and are listed by Underwriters Laboratories Inc. The shell exterior uses an **epoxy powder coating to prevent corrosion** even under the most adverse conditions.

The construction illustrated is used on the C-480 through C-19200 Series Catch-All Filter-Driers (ODF Solder models only). The C-R420, C-30000, and C-40000 Series models differ in construction, but maintain the field-proven features that have been used successfully for many years.

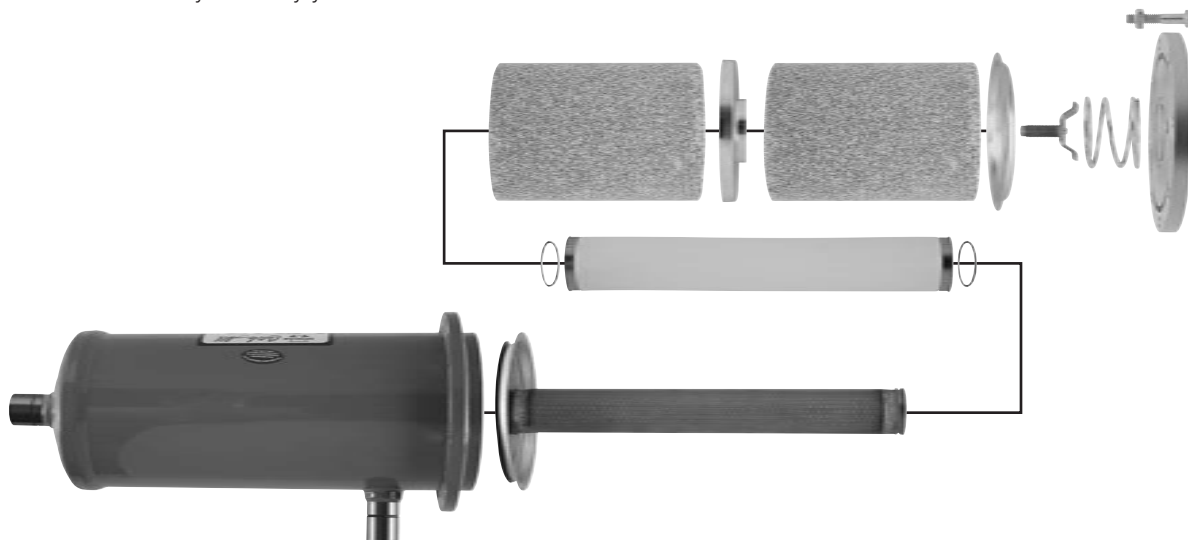



Replaceable Core Type Specifications



Type C-R424-G through C-R427-G
Type C-485-G through C-40033-G
Type C-484-P through C-40016-P

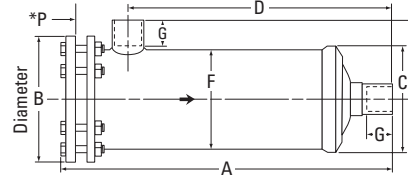

Liquid Line

Inches • lb

TYPE	CONNECTION SIZE Inches ODF Solder	OPTIONAL SECONDARY FILTER **	NO. OF CORES OR FILTER ELEMENTS	CORE PART NUMBER	VOLUME OF DESSICANT Cu. In.	FILTER ELEMENT PART NUMBER	MOUNTING BRACKETS	SHELL DIMENSIONS Inches								SHIPPING WEIGHT lb
								A	B	C	D	E	F	G	*P	
C-R424-G	1/2	—	1	RCW-42	42	—	A-175-1	9.00	4.75	—	6.79	2.61	3.50	.50	6.50	6-1/2
C-R425-G	5/8							9.12			2.73	.62				
C-R427-G	7/8							9.41			3.02	.75				

C-R420 Series have a maximum rated pressure of 650 psi.

C-485-G	5/8	FS-480	1	RCW-48, RC-4864, or RC-4864-HH	48	RPE-48-BD	A-685	9.14	6.00	4.98	5.92	3.50	4.75	.50	7.50	12
C-487-G	7/8							9.29			3.97	.75				
C-489-G	1-1/8							9.49			4.19	.91				
C-4811-G	1-3/8							9.59			4.31	.97				
C-4813-G	1-5/8							9.59			4.32	1.09				
C-967-G	7/8	FS-960	2	RCW-48, RC-4864, or RC-4864-HH	96	RPE-48-BD	A-685	14.83	6.00	4.98	11.61	3.97	4.75	.75	13.00	16
C-969-G	1-1/8							15.03			4.19	.91				
C-9611-G	1-3/8							15.13			4.31	.97				
C-9613-G	1-5/8							15.13			4.32	1.09				
C-1449-G	1-1/8	FS-1440	3	RCW-48, RC-4864, or RC-4864-HH	144	RPE-48-BD	A-685	20.57	6.00	4.98	17.45	4.19	4.75	.91	18.62	20
C-14411-G	1-3/8							20.67			4.31	.97				
C-14413-G	1-5/8							20.67			4.32	1.09				
C-19211-G	1-3/8	FS-19200	4	RCW-48, RC-4864, or RC-4864-HH	192	RPE-48-BD	A-685	26.21	6.00	4.98	22.99	4.31	4.75	.97	24.25	23
C-19213-G	1-5/8							26.21			4.32	1.09				
C-19217-G	2-1/8							26.21			4.41	1.36				

C-480 through C-19200 Series (including NPT pipe connections) have a maximum rated pressure of 650 psi.

C-30013-G	1-5/8	—	3	RCW-100, RC-10098, or RC-10098-HH	300	RPE-100	A-175-2	27.83	7.50	6.25	23.88	5.12	6.00	1.12	25.62	40
C-30017-G	2-1/8							27.89			5.32	1.38				
C-40017-G	2-1/8	—	4	RCW-100, RC-10098, or RC-10098-HH	400	RPE-100	A-175-2	34.42	7.50	6.25	30.50	5.31	6.00	1.38	32.12	47
C-40021-G	2-5/8							35.15			5.75	1.50				
C-40025-G	3-1/8							34.92			5.69	1.75				
C-40029-G	3-5/8							34.92			5.75	1.53				
C-40033-G	4-1/8							34.98			5.81	1.53				

C-30000 & C-40000 Series (including the C-40016-P) have a maximum rated pressure of 500 psi.

NPT PIPE CONNECTIONS																
C-484-P	1/2	—	1	RCW-48, RC-4864, or RC-4864-HH	48	RPE-48-BD	A-685	9.08	6.00	5.00	5.85	3.41	4.75	—	7.50	12
C-966-P	3/4		2		96			14.67			3.68	13.00				
C-1448-P	1		3		144			20.42			3.66	18.62				
C-19212-P	1-1/2		4		192			25.85			3.76	24.25				
C-40016-P	2	—	4	RCW-100, RC-10098, or RC-10098-HH	400	RPE-100	A-175-2	34.44	7.50	6.25	30.38	4.38	6.00	—	32.12	51

cUL_{us} Listed — Guide-SMGT-File No. SA-1756.

* "P" Dimension is the pull space required to change core.

** Optional Secondary Filter must be purchased separately. O-rings (p/n 621-025) are supplied with each secondary filter, but can be purchased separately. The secondary filter cannot be used if the shell is installed in the suction line.

SIGNIFICANCE OF THE TYPE NUMBER SUFFIX

The letters in the Catch-All type number each have a significance.

-G indicates unit is supplied with 1/4" female pipe connection in the flange plate and pipe plug. If the unit is intended for liquid line service an angle charging valve for system charging purposes can be installed in place of the pipe plug. If the unit is

used in the suction line for clean-up after burnout, then insert a Schrader type access valve to serve as a pressure tap. Angle charging and Schrader type access valves are available from your Sporlan wholesaler. NOTE: Catch-All shells with plain flange plate

are available as a non-catalog option with a minimum order requirement.

-P indicates female threaded pipe connections.



Replaceable Core Type Specifications



Type C-R424-G through C-R427-G
Type C-485-G through C-40033-G
Type C-484-P through C-40016-P

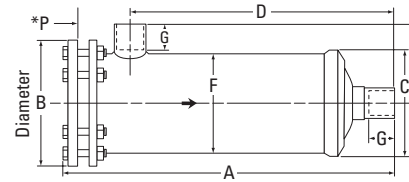

Liquid Line

mm = kg

TYPE	CONNECTION SIZE Inches ODF Solder	OPTIONAL SECONDARY FILTER **	NO. OF CORES OR FILTER ELEMENTS	CORE PART NUMBER	VOLUME OF DESSICANT cm ³	FILTER ELEMENT PART NUMBER	MOUNTING BRACKETS	SHELL DIMENSIONS mm							SHIPPING WEIGHT kg	
								A	B	C	D	E	F	G		*P
C-R424-G C-R425-G C-R427-G	1/2 5/8 7/8	—	1	RCW-42	688	—	A-175-1	229 232 239	121	—	172 176 183	66 69 77	71	13 16 19	13	3.0

C-R420 Series have a maximum rated pressure of 44.8 bar.

C-485-G C-487-G C-489-G C-4811-G C-4813-G	5/8 7/8 1-1/8 1-3/8 1-5/8	FS-480	1	RCW-48, RC-4864, or RC-4864-HH	787	RPE-48-BD	A-685	232 236 241 244 244	152	126	150 154 159 162 162	89 94 96 100 101	121	13 19 23 25 28	191	5.5															
C-967-G C-969-G C-9611-G C-9613-G	7/8 1-1/8 1-3/8 1-5/8	FS-960	2					377 382 384 384			152	126		295 300 303 302			94 96 100 101	121	19 23 25 28	330	7.3										
C-1449-G C-14411-G C-14413-G	1-1/8 1-3/8 1-5/8	FS-1440	3					522 525 525						152			126		443 443 443			106 109 110	121	23 25 28	473	9.1					
C-19211-G C-19213-G C-19217-G	1-3/8 1-5/8 2-1/8	FS-19200	4					666 666 666											152			126		584 584 570			109 110 112	121	25 28 35	616	10.5

C-480 through C-19200 Series (including NPT pipe connections) have a maximum rated pressure of 44.8 bar.

C-30013-G C-30017-G	1-5/8 2-1/8	—	3	RCW-100, RC-10098, or RC-10098-HH	4916	RPE-100	A-175-2	707 708	191	159	607 610	130 135	152	28 35	651	18.2					
C-40017-G C-40021-G C-40025-G C-40029-G C-40033-G	2-1/8 2-5/8 3-1/8 3-5/8 4-1/8	—	4					874 893 887 887 888			191	159		775 776 757 764 757			135 146 145 146 148	152	35 38 44 39 39	816	21.4 21.4 21.4 22.3 22.3

C-30000 & C-40000 Series (including the C-40016-P) have a maximum rated pressure of 34.5 bar.

NPT PIPE CONNECTIONS																						
C-484-P C-966-P C-1448-P C-19212-P	1/2 3/4 1 1-1/2	—	1 2 3 4	RCW-48, RC-4864, or RC-4864-HH	787 1573 2360 3146	RPE-48-BD	A-685	231 373 519 657	152	127	149 291 437 575	87 88 93 96	121	—	191 330 473 616	5.5 7.3 9.1 10.5						
C-40016-P	2	—	4		RCW-100 RC-10098, or RC-10098-HH			6555			RPE-100	A-175-2		875	191	159	772	111	152	—	816	23.2

UL_{US} Listed — Guide-SMGT-File No. SA-1756.

* "P" Dimension is the pull space required to change core.

** Optional Secondary Filter must be purchased separately. O-rings (p/n 621-025) are supplied with each secondary filter, but can be purchased separately. The secondary filter cannot be used if the shell is installed in the suction line.



Cores / Elements

REPLACEABLE CORES AND FILTER ELEMENTS

Order Separately



Cores for replaceable core type filter-driers are molded of exactly the same desiccants that are used in the popular sealed filter-driers.

Cores are individually packed in **metal cans**, fully activated, and hermetically sealed against moisture and dirt.

Filter elements are dried and packed in individual sealed metal cans. This method of packaging prevents the element from picking up moisture from the atmosphere.

Detailed **instructions** are printed on each can. Each can contains a **"triple gasket"** consisting of a new endplate gasket, an endplate gasket for certain competitive filter-driers, and a core gasket where desired. See the specifications on pages 24 and 25 for the number of cores required for each type filter-drier.

RCW-42

High Water Capacity Core — Order as separate item—Fits ONLY shell types C-R424-G, C-R425-G, and C-R427-G. **Designed specially for use with POE lubricants.** This core should be used on systems that have a ruptured water cooled condenser, or that have been exposed to the atmosphere, or for some reason have a high amount of moisture in the system.

RC-4864

Activated Core — Order as separate item—Fits types C-480 thru C-19200 Series shells and Replaceable Suction Filter (RSF) shells. This is the traditional core suitable for liquid and suction line applications in mineral oil systems.

RCW-48

High Water Capacity Core — Order as separate item—Fits types C-480 thru C-19200 Series shells and Replaceable Suction Filter (RSF) shells. **Designed specially for use with POE lubricants.** This core should be used on systems that have a ruptured water cooled condenser, or that have been exposed to the atmosphere, or for some reason have a high amount of moisture in the system.

RC-4864-HH

Activated Charcoal Core — Order as separate item—Fits types C-480 thru C-19200 Series shells and Replaceable Suction Filter (RSF) shells. This core should be used for wax removal on low temperature systems, and for clean-up of systems that have had a hermetic motor burnout.

RPE-48-BD

Filter Element — Order as a separate item—Fits types C-480 thru C-19200 Series shells and Replaceable Suction Filter (RSF) shells. This element should be used in RSF shells installed in the suction line to obtain the lowest possible pressure drop after cores were used for system clean-up.

FS - SECONDARY FILTERS

Core Filter Element — Order as a separate item—Fits types C-480 thru C-19200 Series shells. 25 micron filter is ideal during system commissioning or clean-up. Do not use on suction line.

RC-10098

Activated Core — Order as separate item—Fits types C-30000 and C-40000 Series shells. This is the traditional core suitable for liquid and suction line applications in mineral oil systems.

RCW-100

High Water Capacity Core — Order as separate item—Fits types C-30000 and C-40000 Series shells. **Designed specially for use with POE lubricants.** This core should be used on systems that have a ruptured water cooled condenser, or that have been exposed to the atmosphere, or for some reason have a high amount of moisture in the system.

RC-10098-HH

Activated Charcoal Core — Order as separate item—Fits types C-30000 and C-40000 Series shells. This core should be used for wax removal on low temperature systems, and for clean-up of systems that have had a hermetic motor burnout.

RPE-100

Filter Element — Order as a separate item—Fits types C-30000 and C-40000 Series shells. This filter element should be used in the suction line to obtain the lowest possible pressure drop after cores were used for system clean-up.

Sporlan cores and filter elements can replace drier shells made by most other filter-drier manufacturers.



Catch-All® Cores / Elements

Unit Net Weights and Carton Shipping Weights

PART NUMBER	NUMBER PER CARTON	NET WEIGHT Each		SHIPPING WEIGHT		CORE DIMENSIONS O.D. x Length	
		lb	kg	lb	kg	Inches	mm
REPLACEABLE CORES							
RCW-42	10	1.5	0.7	19	8.6	3.18 x 6.00	81 x 152
RC-4864 RCW-48 RC-4864-HH	12	1.9	0.9	28	12.7	3.74 x 5.50	95 x 140
RC-10098 RCW-100 RC-10068-HH	6	4.2	1.9	28	12.7	4.80 x 6.47	122 x 164
FILTER ELEMENTS							
RPE-48-BD	12	0.8	0.4	13	5.9	3.70 x 5.50	94 x 140
RPE-100	6	1.1	0.5	9	4.1	4.80 x 6.47	122 x 164
SECONDARY FILTERS							
FS-480	36	0.2	0.09	5.8	2.6	1.60 x 5.37	41 x 136
FS-960	36	0.2	0.09	8.6	3.9	1.60 x 10.90	41 x 277
FS-1440	24	0.3	0.14	8.2	3.7	1.60 x 16.44	41 x 418
FS-19200	25	0.4	0.18	11	5.0	1.60 x 21.97	41 x 558



Liquid Line

Ratings and Selection Recommendations

Replaceable Core Type – Refrigerant 134a



134a

For suction line filter-driers see page 34

For sealed model Catch-Alls see page 10

TYPE	SURFACE FILTERING AREA		RATINGS AT AHRI STANDARD CONDITIONS				SELECTION RECOMMENDATIONS (Tons)		
	Sq. Inch	cm ²	WATER CAPACITY DROPS AT 50 PPM		REFRIGERANT FLOW CAPACITY		REFRIGERATION Commercial & Low Temperature Equipment	AIR CONDITIONING	
			75°F 25°C	125°F 50°C	Tons at 1 psi ΔP	kW at 0.07 bar ΔP		O.E.M. Self Contained	Field Replacement or Field Built-Up Systems
RCW-42 (High Water Capacity Core)									
C-R424-G	67	432	981	706	10.4	36.5	3	5	5
C-R425-G					12.5	43.9	5	10	7-1/2
C-R427-G					16.9	59.3			
RCW-48 or RCW-100 (High Water Capacity Cores)									
C-485-G	64	413	1201	868	13.4	47.0	7-1/2	10	7-1/2
C-487-G					21.9	76.9	12	15	12
C-489-G					39.5	138.6	12	25	15
C-967-G	128	826	2402	1736	35.9	126.0	20	30	20
C-969-G					44.5	156.2	25	35	25
C-1449-G	192	1239	3603	2604	54.1	189.9	30	40	30
C-14411-G					61.3	215.2	40	50	40
C-19211-G	256	1652	4804	3472	77.3	271.3	50	60	50
C-19213-G					90.6	318.0	60	80	60
C-19217-G					95.1	333.8	65	80	65
C-30013-G	294	1897	7375	5310	102	358.0	75	110	75
C-40017-G	392	2529	9833	7080	132	463.3	110	130	110
RC-4864 or RC-10098 (Standard Cores)									
C-485-G	64	413	583	473	13.4	47.0	7-1/2	10	7-1/2
C-487-G					21.9	76.9	12	15	12
C-489-G					39.5	138.6	12	25	15
C-967-G	128	826	1166	946	35.9	126.0	20	30	20
C-969-G					44.5	156.2	25	35	25
C-1449-G	192	1239	1749	1419	54.1	189.9	30	40	30
C-14411-G					61.3	215.2	40	50	40
C-19211-G	256	1652	2332	1892	77.3	271.3	50	60	50
C-19213-G					90.6	318.0	60	80	60
C-19217-G					95.1	333.8	65	80	65
C-30013-G	294	1897	3912	3009	102	358.0	75	110	75
C-40017-G	392	2529	5216	4012	132	463.3	110	130	110

NOTES: The variation in flow ratings of filter-driers having the same size core and shell is caused by the difference in connection sizes used. Installing the secondary filter in C-480 through C-19200 Series shells reduces the flow capacity by approximately 5 percent. R-12 water capacity values are approximately 15 percent greater than R-134a values.



Liquid Line

Ratings and Selection Recommendations

Replaceable Core Type – Refrigerant 22

TYPE	SURFACE FILTERING AREA		RATINGS AT AHRI STANDARD CONDITIONS				SELECTION RECOMMENDATIONS (Tons)			
	Sq. Inch	cm ²	WATER CAPACITY DROPS AT 60 PPM		REFRIGERANT FLOW CAPACITY		REFRIGERATION	AIR CONDITIONING		
			75°F 25°C	125°F 50°C	Tons at 1 psi ΔP	kW at 0.07 bar ΔP	Commercial & Low Temperature Equipment	O.E.M. Self Contained	Field Replacement or Field Built-Up Systems	
RCW-42 (High Water Capacity Core)										
C-R424-G	67	432	902	735	11.4	40.0	5	7-1/2	15	10
C-R425-G					13.7	48.1	7-1/2			
C-R427-G					18.5	64.9	7-1/2			
RCW-48 or RCW-100 (High Water Capacity Cores)										
C-485-G	64	413	1109	904	14.6	51.2	10	15	10	
C-487-G					23.9	83.9	15	20	15	
C-489-G					43.2	151.6	15	30	20	
C-967-G	128	826	2218	1808	39.2	137.6	25	35	25	
C-969-G					48.7	170.9	35	40	35	
C-1449-G	192	1239	3327	2712	59.2	207.8	40	50	40	
C-14411-G					67.0	235.2	50	60	50	
C-19211-G					84.5	296.6	70	80	70	
C-19213-G	256	1652	4436	3616	99.0	347.5	80	100	80	
C-19217-G					104	365.0	85	100	85	
C-30013-G	294	1897	6786	5532	112	393.1	100	125	100	
C-40017-G	392	2529	9048	7376	134	470.3	130	150	130	
RC-4864 or RC-10098 (Standard Cores)										
C-485-G	64	413	347	288	14.6	51.2	10	15	10	
C-487-G					23.9	83.9	15	20	15	
C-489-G					43.2	151.6	15	30	20	
C-967-G	128	826	694	576	39.2	137.6	25	35	25	
C-969-G					48.7	170.9	35	40	35	
C-1449-G	192	1239	1041	864	59.2	207.8	40	50	40	
C-14411-G					67.0	235.2	50	60	50	
C-19211-G					84.5	296.6	70	80	70	
C-19213-G	256	1652	1388	1152	99.0	347.5	80	100	80	
C-19217-G					104	365.0	85	100	85	
C-30013-G	294	1897	2670	1878	112	393.1	100	125	100	
C-40017-G	392	2529	3560	2504	134	470.3	130	150	130	



22

For suction line
filter-driers
see page 34

For sealed model
Catch-Alls
see page 10

NOTE: The variation in flow ratings of filter-driers having the same size core and shell is caused by the difference in connection sizes used. Installing the secondary filter in C-480 through C-19200 Series shells reduces the flow capacity by approximately 5 percent.



Liquid Line

Ratings and Selection Recommendations

Replaceable Core Type – Refrigerant 404A & 507



404A & 507

TYPE	SURFACE FILTERING AREA		RATINGS AT AHRI STANDARD CONDITIONS				SELECTION RECOMMENDATIONS (Tons)		
	Sq. Inch	cm ²	WATER CAPACITY DROPS AT 60 PPM		REFRIGERANT FLOW CAPACITY		REFRIGERATION	AIR CONDITIONING	
			75°F 25°C	125°F 50°C	Tons at 1 psi ΔP	kW at 0.07 bar ΔP		Commercial & Low Temperature Equipment	O.E.M. Self Contained
RCW-42 (High Water Capacity Core)									
C-R424-G	67	432	1049	853	7.6	26.7	5	7-1/2	7-1/2
C-R425-G					9.1	31.9			
C-R427-G					12.4	43.5			
RCW-48 or RCW-100 (High Water Capacity Cores)									
C-485-G	64	413	1290	1049	9.8	34.4	7-1/2	10	7-1/2
C-487-G					16.0	56.2	10	12	10
C-489-G					28.9	101.4	10	20	10
C-967-G	128	826	2580	2098	26.2	92.0	15	20	15
C-969-G					32.6	114.4	25	30	25
C-1449-G	192	1239	3870	3147	39.7	139.3	30	35	30
C-14411-G					44.8	157.2	35	40	35
C-19211-G	256	1652	5160	4196	56.3	197.6	50	50	50
C-19213-G					66.2	232.4	55	60	55
C-19217-G					69.5	243.9	60	65	60
C-30013-G	294	1897	7890	6417	74.5	261.5	70	80	70
C-40017-G	392	2529	10520	8556	96.8	339.8	100	125	100
RC-4864 or RC-10098 (Standard Cores)									
C-485-G	64	413	408	309	9.8	34.4	7-1/2	10	7-1/2
C-487-G					16.0	56.2	10	12	10
C-489-G					28.9	101.4	10	20	10
C-967-G	128	826	816	618	26.2	92.0	15	20	15
C-969-G					32.6	114.4	25	30	25
C-1449-G	192	1239	1224	927	39.7	139.3	30	35	30
C-14411-G					44.8	157.2	35	40	35
C-19211-G	256	1652	1632	1236	56.3	197.6	50	50	50
C-19213-G					66.2	232.4	55	60	55
C-19217-G					69.5	243.9	60	65	60
C-30013-G	294	1897	2631	1992	74.5	261.5	70	80	70
C-40017-G	392	2529	3508	2656	96.8	339.8	100	125	100

NOTE: The variation in flow ratings of filter-driers having the same size core and shell is caused by the difference in connection sizes used. Installing the secondary filter in C-480 through C-19200 Series shells reduces the flow capacity by approximately 5 percent. R-502 water capacities are similar to R-404A and R-507.

For suction line
filter-driers
see page 34

For sealed model
Catch-Alls
see page 10



Liquid Line

Ratings and Selection Recommendations

Replaceable Core Type – Refrigerant 407A

TYPE	SURFACE FILTERING AREA		RATINGS AT AHRI STANDARD CONDITIONS				SELECTION RECOMMENDATIONS (Tons)		
			WATER CAPACITY DROPS AT 60 PPM		REFRIGERANT FLOW CAPACITY		REFRIGERATION	AIR CONDITIONING	
	Sq. Inch	cm ²	75°F 25°C	125°F 50°C	Tons at 1 psi ΔP	kW at 0.07 bar ΔP		Commercial Low Temperature Equipment	O.E.M. Self Contained
RCW-42 (High Water Capacity Core)									
C-R424-G	67	432	760	245	9.9	34.8	5	7-1/2	5
C-R425-G					11.9	41.8	7-1/2	15	10
C-R427-G					16.1	56.5			
RCW-48 or RCW-100 (High Water Capacity Cores)									
C-485-G	64	413	728	535	12.7	44.6	10	15	10
C-487-G					20.8	73.0	15	20	15
C-489-G					37.6	132.0	15	30	20
C-967-G	128	826	1455	1071	34.1	119.7	25	35	25
C-969-G					42.4	148.8	35	40	35
C-1449-G	192	1239	2183	1606	51.5	180.8	40	50	40
C-14411-G					58.3	204.6	50	60	50
C-19211-G					73.5	258.0	70	80	70
C-19213-G	256	1652	2910	2142	86.2	302.6	80	100	80
C-19217-G					90.5	317.7	85	100	85
C-30013-G	294	1897	4724	3476	97.1	340.8	100	125	100
C-40017-G	392	2529	6299	4635	126.0	442.3	130	150	130



407A

Replaceable Core Type – Refrigerant 407C

TYPE	SURFACE FILTERING AREA		RATINGS AT AHRI STANDARD CONDITIONS				SELECTION RECOMMENDATIONS (Tons)		
			WATER CAPACITY DROPS AT 60 PPM		REFRIGERANT FLOW CAPACITY		REFRIGERATION	AIR CONDITIONING	
	Sq. Inch	cm ²	75°F 25°C	125°F 50°C	Tons at 1 psi ΔP	kW at 0.07 bar ΔP		Commercial Low Temperature Equipment	O.E.M. Self Contained
RCW-42 (High Water Capacity Core)									
C-R424-G	67	432	760	245	10.5	36.9	5	7-1/2	5
C-R425-G					12.5	43.9	7-1/2	15	10
C-R427-G					17.0	59.7			
RCW-48 or RCW-100 (High Water Capacity Cores)									
C-485-G	64	413	934	301	13.5	47.4	10	15	10
C-487-G					22.0	77.2	15	20	15
C-489-G					39.8	139.7	15	30	20
C-967-G	128	826	1868	602	36.1	126.7	25	35	25
C-969-G					44.8	157.2	35	40	35
C-1449-G	192	1239	2802	903	54.6	191.6	40	50	40
C-14411-G					61.7	216.6	50	60	50
C-19211-G					77.7	272.7	70	80	70
C-19213-G	256	1652	3736	1204	91.1	319.8	80	100	80
C-19217-G					95.7	335.9	85	100	85
C-30013-G	294	1897	5716	1844	103	361.5	100	125	100
C-40017-G	392	2529	7621	2458	133	466.8	130	150	130

407C

For suction line filter-driers see page 34

For sealed model Catch-Alls see page 10



Liquid Line

Ratings and Selection Recommendations

Replaceable Core Type – Refrigerant 407F

407F

TYPE	SURFACE FILTERING AREA		RATINGS AT AHRI STANDARD CONDITIONS				SELECTION RECOMMENDATIONS (Tons)			
			WATER CAPACITY DROPS AT 60 PPM		REFRIGERANT FLOW CAPACITY		REFRIGERATION	AIR CONDITIONING		
	Sq. Inch	cm ²	75°F 25°C	125°F 50°C	Tons at 1 psi ΔP	kW at 0.07 bar ΔP		Commercial Low Temperature Equipment	O.E.M. Self Contained	Field Replacement or Field Built-Up Systems
RCW-42 (High Water Capacity Core)										
C-R424-G	67	432	760	245	10.9	38.3	5	7-1/2	15	10
C-R425-G					13.1	46.0				
C-R427-G					17.7	62.1				
RCW-48 or RCW-100 (High Water Capacity Cores)										
C-485-G	64	413	480	357	14.1	49.5	10	15	10	
C-487-G					22.9	80.4	15	20	15	
C-489-G					41.4	145.3	15	30	20	
C-967-G	128	826	961	714	37.6	132.0	25	35	25	
C-969-G					46.7	163.9	35	40	35	
C-1449-G					56.8	199.4	40	50	40	
C-14411-G	192	1239	1441	1071	64.3	225.7	50	60	50	
C-19211-G					81.0	284.3	70	80	70	
C-19213-G					95.0	333.5	80	100	80	
C-19217-G	256	1652	1922	1420	99.7	349.9	85	100	85	
C-30013-G					107.0	375.6	100	125	100	
C-40017-G					139.0	487.9	130	150	130	

Replaceable Core Type – Refrigerant 410A

410A

TYPE	SURFACE FILTERING AREA		RATINGS AT AHRI STANDARD CONDITIONS				SELECTION RECOMMENDATIONS (Tons)			
			WATER CAPACITY DROPS AT 60 PPM		REFRIGERANT FLOW CAPACITY		REFRIGERATION	AIR CONDITIONING		
	Sq. Inch	cm ²	75°F 25°C	125°F 50°C	Tons at 1 psi ΔP	kW at 0.07 bar ΔP		Commercial Low Temperature Equipment	O.E.M. Self Contained	Field Replacement or Field Built-Up Systems
RCW-42 (High Water Capacity Core)										
C-R424-G	67	432	407	305	11.2	39.3	5	7-1/2	15	10
C-R425-G					13.4	47.0				
C-R427-G					18.1	63.5				
RCW-48 or RCW-100 (High Water Capacity Cores)										
C-485-G	64	413	481	361	14.3	50.2	10	15	10	
C-487-G					23.3	81.8	15	20	15	
C-489-G					42.2	148.1	15	30	20	
C-967-G	128	826	962	722	38.3	134.4	25	35	25	
C-969-G					47.5	166.7	35	40	35	
C-1449-G					57.9	203.2	40	50	40	
C-14411-G	192	1239	1443	1083	65.4	229.6	50	60	50	
C-19211-G					82.4	289.2	70	80	70	
C-19213-G					96.6	339.1	80	100	80	
C-19217-G	256	1652	1924	1444	101	354.5	85	100	85	

For suction line filter-driers see page 34

For sealed model Catch-Alls see page 10

NOTE: The variation in flow ratings of filter-driers having the same size core and shell is caused by the difference in connection sizes used. Installing the secondary filter in C-480 through C-19200 Series shells reduces the flow capacity by approximately 5 percent.



Liquid Line HH Style for Wax Removal



Type C-052-HH through C-417-S-HH
Type RC-4864-HH through RC-10098-HH
Maximum Rated Pressure of 650 psi / 44.8 bar

Small amounts of wax are often a problem on **low temperature systems**. Even well engineered systems frequently contain minute quantities of wax that are sufficient to clog expansion valve screens or cause sticking of the valve. Sporlan has developed a special blend of desiccants, including activated charcoal, that

removes small amounts of wax in the liquid line before the wax can cause trouble at the expansion valve. These Catch-All Filter-Driers have been very successful in correcting trouble jobs in the field.

Select an HH Style Catch-All Filter-Drier if wax problems occur on low

temperature systems. In addition to their wax removal ability, these filter-driers will remove all of the other harmful contaminants that the standard filter-driers remove. Listed in the table are various Catch-All models that incorporate the HH style core.

Specifications

Inches • lb

TYPE		CONNECTION SIZE Inches	VOLUME OF DESSICANT Cubic Inches	OVERALL LENGTH Inches		SOLDER SOCKET DEPTH Inches	DIAMETER OF BODY Inches	SHIPPING WEIGHT lb
SAE Flare	ODF Solder			SAE Flare	ODF Solder			
C-052-HH	C-052-S-HH	1/4	5	4.72	4.26	0.37	2.44	3/4
C-082-HH	—	1/4	9	5.62	5.16	—	2.62	1-1/4
C-083-HH	C-083-S-HH	3/8		6.06	5.30	0.44		
C-162-HH	—	1/4	16	6.28	5.82	—	3.00	1-3/4
C-163-HH	C-163-S-HH	3/8		6.72	5.96	0.44		
C-164-HH	C-164-S-HH	1/2		6.98	6.08	0.50		
C-165-HH	C-165-S-HH	5/8		7.28	6.32	0.62		
C-303-HH	—	3/8	30	9.62	8.86	—	3.00	3-1/2
C-304-HH	C-304-S-HH	1/2		9.88	8.98	0.50		
C-305-HH	C-305-S-HH	5/8		10.18	9.22	0.62		
C-414-HH	—	1/2	41	9.88	8.98	—	3.50	4-1/2
C-415-HH	—	5/8		10.18	9.22	—		
—	C-417-S-HH	7/8		—	9.82	0.75		
RC-4864-HH	—	Replaceable Core	See Pages 24 and 25 for Replaceable Core Type Catch-All Specifications					
RC-10098-HH	—							

Specifications

mm • kg

TYPE		CONNECTION SIZE Inches	VOLUME OF DESSICANT cm ³	OVERALL LENGTH mm		SOLDER SOCKET DEPTH mm	DIAMETER OF BODY mm	SHIPPING WEIGHT kg
SAE Flare	ODF Solder			SAE Flare	ODF Solder			
C-052-HH	C-052-S-HH	1/4	82	120	108	9	62	0.34
C-082-HH	—	1/4	174	143	131	—	67	0.57
C-083-HH	C-083-S-HH	3/8		154	135	11		
C-162-HH	—	1/4	262	160	148	—	76	0.80
C-163-HH	C-163-S-HH	3/8		171	151	11		
C-164-HH	C-164-S-HH	1/2		177	154	13		
C-165-HH	C-165-S-HH	5/8		185	161	16		
C-303-HH	—	3/8	492	246	225	—	76	1.60
C-304-HH	C-304-S-HH	1/2		251	228	13		
C-305-HH	C-305-S-HH	5/8		259	234	16		
C-414-HH	—	1/2	672	251	230	—	89	2.00
C-415-HH	—	5/8		259	237	—		
—	C-417-S-HH	7/8		—	249	19		
RC-4864-HH	—	Replaceable Core	See Pages 24 and 25 for Replaceable Core Type Catch-All Specifications					
RC-10098-HH	—							



Suction Line Filter-Driers

Sporlan Suction Line Filter-Driers are designed specifically for **CLEAN-UP** after **BURNOUT** using the **HH TYPE CHARCOAL CORE**

PROVEN BENEFITS:

- Positive protection for the compressor
- Most economical method of clean-up
- Minimum down time — system operates during clean-up
- Method is applicable to almost any size system
- Removes all contaminants — moisture, acid, sludges, dirt...
- Recommended by the leading equipment manufacturers

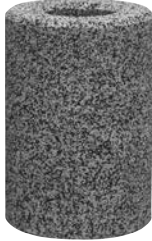

METHOD OF CLEAN-UP

The Suction Line Filter-Drier method of cleaning up a system after a hermetic motor burnout is favored by service technicians and recommended by manufacturers throughout our industry. This method gives the most practical and positive protection of the new compressor, since the refrigerant-lubricant mixture is filtered and purified just before it returns to the compressor. It is important that all contaminants remaining in the system be removed to prevent a repeat burnout of the new compressor.

CONSTRUCTION

The construction of the suction line filter-drier is not significantly different from the standard liquid line filter-drier. Both driers remove the important contaminants such as moisture, dirt, acid, and the products of lubricant decomposition. The suction line filter-driers utilizes the HH style charcoal core to obtain the maximum ability for lubricant clean-up and removing all types of contaminants. The sealed models have an access valve (-T) at the inlet end to permit measuring the pressure drop during the first several hours of operation. RSF shells have an access valve to measure pressure drop (see Bulletin 80-10). Also, replaceable core Catch-Alls have a 1/4" female pipe connection (-G) in the endplate to

permit the installation of an access valve to measure pressure drop. If the proper style drier is not available, then a suction line filter-drier can be used in the suction or liquid line; and a liquid line filter-drier can be used in the suction line. The pressure drop characteristics of the two types of driers are essentially the same for a given line size.

INSTALLATION

The Catch-All Filter-Drier can be installed directly in the suction line by removing a portion of the line. **After clean-up, the Catch-All Filter-Drier is generally left in the line. The cores in the replaceable model or RSF shell should be replaced with filter elements (RPE-48-BD or RPE-100) to obtain the lowest possible pressure drop.** A hermetic motor burnout produces large amounts of acid, moisture, sludge and all types of lubricant decomposition materials. To obtain the maximum ability to remove all these various types of contaminants, the Sporlan HH style charcoal core is preferred. If the HH style core is not available, the standard cores may be used.

IMPORTANCE OF LUBRICANT AS A SCAVENGER

OEM recommendations stress the importance of lubricant in cleaning up a system after a motor burnout. The lubricant acts as a scavenger, collecting the acid, sludges, and other contaminants. Therefore, the service technician should check the **color** and **acid content** of the lubricant. It must be clean and acid free before the job is finished. The acid content can be checked with an acid test kit.

OBTAINING A LUBRICANT SAMPLE

This is frequently a difficult task. A lubricant sample can usually be obtained from the burned out compressor. To obtain repeated samples after the system is started up, install a trap in the suction line with an access valve in the bottom of the trap. This permits collecting the small amount of lubricant required for

running an acid test. Another method is to build a trap with valves, and connections for charging hoses. Then refrigerant vapor from the discharge service valve is run through this trap and put back into the suction service valve. In a short time sufficient lubricant collects in the trap for analysis. For more information request Sporlan Form 40-141.

SUCTION LINE PRESSURE DROP

Most hermetic motors rely on refrigerant vapor for cooling. Any large pressure drop in the suction line could result in reduced flow of suction gas, and thus improper cooling of the new hermetic motor. Field experience has shown that if the filter-drier is properly sized, the pressure drop across it should not exceed the values given in the table on page 35. **The pressure drop across the filter-drier should be checked during the first hour of operation to determine if the cores need to be changed.**

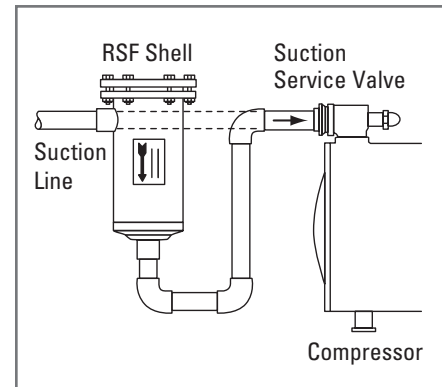

Any pressure loss in the suction line also reduces system capacity significantly. When an RSF shell or replaceable core type Catch-All is used, it is recommended that the cores be removed and filter elements installed when the clean-up job is complete. Obtaining a low pressure drop is particularly important for energy savings on supermarket refrigeration systems. Therefore, suction line filter-driers should be sized generously on these systems.



Clean-Up Procedure

1. **DIAGNOSIS** — Make certain that a motor burnout has actually occurred by running the proper electrical tests. Determine the severity of the burnout by analyzing the acid content of the lubricant from the burned out compressor. This can be done on the job with a TA-1 One Time Acid Test Kit. Note the color of the lubricant, the smell of the refrigerant, and if carbon deposits are present in the suction line.

2. **PLAN THE PROCEDURE** — Consider the following factors: If the lubricant is not acidic and none of the other indications of severe burnout are present, then the system can be classified as a “mild burnout” and cleaned up accordingly. Under these circumstances, it is easier to save the refrigerant. If a lubricant sample is desired for checking the progress of the clean-up, then a trap should be installed in the suction line (see Form 40-141). A semi-hermetic compressor can be examined and cleaned by having the head removed. A heat pump system will frequently require replacing the 4-way valve, or other special precautions. Systems with a critical charge must have the charge adjusted due to the added volume in the oversized filter-drier that is normally installed in the liquid line.

3. **MILD BURN-OUT** — If the analysis of the lubricant shows no acidity, then the system can be classified as a mild burnout, and cleaned up simply by installing an oversized Catch-All Filter-Drier in the liquid line. Install a secondary filter with new cores in replaceable core Catch-Alls. Monitor pressure drop and replace as needed. If the lubricant is not analyzed, and the other factors indicate some doubt, then the burnout should be considered severe and cleaned up as described below.

CAUTION — Acid burns can result from touching the sludge in the burned out compressor. Rubber gloves should be worn when handling contaminated parts.

4. **SEVERE BURNOUTS** — These systems should be cleaned using the **suction line filter-drier method**. The refrigerant in the system can be saved, and must be removed using refrigerant recovery/recycling equipment. The exact method chosen depends upon the availability of shutoff valves, the amount of charge, and the other equipment available. See the section on “Saving the Refrigerant.”

5. Remove the burned out compressor and install the new compressor.

6. Install a Catch-All Suction Line Filter-Drier or RSF shell (selected from pages 38 and 39) ahead of the new compressor. The access valve on the drier permits the pressure drop to be checked by installing gauges on the access valve and at the gauge port on the suction service valve. For systems without service valves, install a line tap valve downstream of the Catch-All Filter-Drier for the second connection.

7. Remove the liquid line drier and install an oversized Catch-All (one size larger than the normal selection size). Install a secondary filter with new cores in replaceable core Catch-Alls. Monitor pressure drop and replace as needed. Check the expansion valve and other controls to see if cleaning or replacement is required. Install a See•All Moisture and Liquid Indicator.

8. Evacuate the system according to the manufacturer’s recommendations. Normally this will include the use of a high vacuum pump and a low vacuum micron gauge for measuring the vacuum obtained.

9. Recharge the system through the access valve on the suction line filter-drier. Then start the system according to the manufacturer’s instructions.

10. The use of a Catch-All Filter-Drier installed permanently in the suction line permits the clean-up of a small system to be completed with one service call. The pressure drop across the suction line filter-drier should be measured during the first hour’s operation. If the pressure drop becomes excessive, then the suction line filter-drier should be replaced. If the equipment manufacturer’s recommendations are not available, the following maximum pressure drop

levels are suggested. See table below.

11. In 24 hours take a lubricant sample. Observe the color and test for acidity. If the lubricant is dirty or acidic, replace the suction line and liquid line filter-driers.

In two weeks re-check the color and acidity of the lubricant to see if another change of filter-driers is necessary. It may also be desirable to change the lubricant in the compressor. Before the job is complete, it is essential that the lubricant be clean and acid-free.

SAVING THE REFRIGERANT — The refrigerant is not damaged by the burnout, and can be reused, provided the contaminants are removed. When a mild burnout has occurred on a system with service valves, the refrigerant can be saved by closing the valves and trapping the refrigerant in the system, while changing the compressor. **The system can then be pumped down with the new compressor to save the refrigerant while installing an oversized Catch-All Filter-Drier in the liquid line.**

If a severe burnout has occurred, the above procedure might damage the new compressor. Therefore, it is preferred that the refrigerant be removed from the system for reclamation. If no service valves are available then the refrigerant **must** be removed from the system. Recovery, recycling or reclamation of the refrigerant must be performed in accordance with EPA regulations.

Sporlan recommends the use of our HH style cores for cleaning up all systems after a hermetic motor burnout. These cores contain a desiccant mix that is suitable for removing all types of system contaminants. Form 40-109 is available for selection recommendations on suction line filter-driers. Information on cleaning up centrifugal systems is given in Bulletin 240-10-3. Information on clean-up after a hermetic motor burnout is also given in Section 91 of the SAM Manual published by the Refrigeration Service Engineers Society.

Suction Line Filter-Drier Maximum Recommended Pressure Drop – psi (bar)

SYSTEM	PERMANENT INSTALLATION		TEMPORARY INSTALLATION	
	REFRIGERANT			
	22, 404A, 407A, 407C, 410A, 502, & 507	134a	22, 404A, 407A, 407C, 410A, 502, & 507	134a
Air Conditioning	3 (0.21)	2 (0.14)	8 (0.55)	6 (0.41)
Commercial	2 (0.14)	1-1/2 (0.10)	4 (0.28)	3 (0.21)
Low Temperature	1 (0.07)	1/2 (0.03)	2 (0.14)	1 (0.07)



For New Systems and Clean-Up After Burnout Suction Line Filter-Drier Specifications



Type C-083-S-T-HH through C-609-S-T-HH
Type RSF-487-T through RSF-9625-T
Type C-30013-G through C-40033-G

Suction Line - Sealed Type

Inches • lb

TYPE	CONNECTION SIZE Inches ODF Solder	OVERALL LENGTH Inches	SOLDER SOCKET DEPTH Inches	DIAMETER of BODY Inches	SHIPPING WEIGHT lb
C-083-S-T-HH	3/8	5.30	0.44	2.62	1-1/4
C-084-S-T-HH	1/2	5.42	0.50		
C-164-S-T-HH	1/2	6.08	0.50	3.00	1-3/4
C-165-S-T-HH	5/8	6.32	0.62		
C-166-S-T-HH	3/4	6.77	0.62		
C-167-S-T-HH	7/8	6.92	0.75		
C-305-S-T-HH	5/8	9.22	0.62	3.00	3-1/2
C-306-S-T-HH	3/4	9.67	0.62		
C-307-S-T-HH	7/8	9.82	0.75		
C-309-S-T-HH	1-1/8	9.77	0.91		
C-417-S-T-HH	7/8	9.82	0.75	3.50	4-1/2
C-419-S-T-HH	1-1/8	9.77	0.91		
C-437-S-T-HH	7/8	10.34	0.75	4.75	8
C-439-S-T-HH	1-1/8	10.74	0.91		
C-4311-S-T-HH	1-3/8	10.94	0.97		
C-4313-S-T-HH	1-5/8	10.94	1.09		
C-607-S-T-HH	7/8	15.93	0.75	3.00	6
C-609-S-T-HH	1-1/8	15.85	0.91		

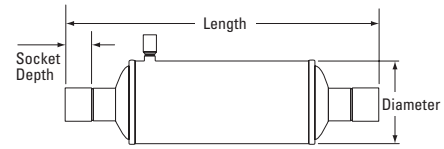

SEALED TYPE

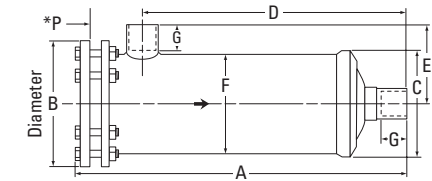

REPLACEABLE CORE TYPE



C-080 through C-600 Series have a maximum rated pressure of 650 psi.

Suction Line - Replaceable Core Type

Inches • lb

TYPE	CONNECTION SIZE Inches ODF Solder	NO. OF CORES OR FILTER ELEMENTS	CORE OR ELEMENT PART NUMBER	MOUNTING BRACKET	SHELL DIMENSIONS Inches								SHIPPING WEIGHT lb	
					A	B	C	D	E	F	G	*P		
RSF-487-T	7/8	1	RC-4864-HH, RC-4864 or RCW-48 Cores	A-685	9.30	6.00	5.00	6.07	3.97	4.75	0.75	7.00	12	
RSF-489-T	1-1/8				9.50			6.27	4.19		0.91			
RSF-4811-T	1-3/8				9.60			6.37	4.31		0.97			
RSF-4813-T	1-5/8				9.60			6.37	4.32		1.09			
RSF-4817-T	2-1/8				9.60			5.81	4.41		1.35			
RSF-4821-T	2-5/8				9.65			5.56	5.19		1.53			
RSF-9617-T	2-1/8	2	RPE-48-BD Element	A-175-2	14.96	7.50	6.25	11.35	4.41	6.00	1.36	32.12		17
RSF-9621-T	2-5/8				15.43			11.10	5.19		1.53			
RSF-9625-T	3-1/8				15.12			10.65	4.91		1.75			

For Systems Requiring the Maximum Amount of Desiccant

C-30013-G	1-5/8	3	RC-10098-HH, RC-10098 or RCW-100 Cores	A-175-2	27.94	7.50	6.25	23.88	5.12	6.00	1.12	25.62	40
C-30017-G	2-1/8				28.06			24.00	5.12		1.38		
C-40017-G	2-1/8	4	RPE-100 Element	A-175-2	34.56	7.50	6.25	30.50	5.31	6.00	1.38	32.12	47
C-40021-G	2-5/8				34.75			30.56	5.38		1.50		
C-40025-G	3-1/8				34.44			29.81	5.06		1.75		
C-40029-G	3-5/8				34.81			30.06	5.50		2.00		
C-40033-G	4-1/8				35.12			29.81	5.62		2.19		

RSF-480, RSF-9600, C-30000 & C-40000 Series have a maximum rated pressure of 500 psi.

cUL_{us} Listed — Guide-SMGT-File No. SA-1756.

NOTE: Refer to Bulletin 80-10 for additional information on RSF shells. Screen P/N: 6171-5 is recommended when cores are used in these shells.

* "P" Dimension is the pull space required to change core.

SIGNIFICANCE OF THE TYPE NUMBER The letters and numerals in the Catch-All type number each have a significance.

- C** indicates Catch-All.
- RSF** indicates Replaceable Suction Filter.
- FIRST TWO OR THREE DIGITS** indicates the cubic inches of desiccant in the given drier size.
- LAST ONE OR TWO DIGITS** indicates the fitting size in eighths of an inch. For

- example: a "4" indicates 1/2" fitting size; a "13" indicates a 1-5/8" fitting size.
- Other suffix letters indicate special qualities. Examples:
- T** indicates a pressure tap consisting of a Schrader type access valve on

- the inlet end of the Catch-All or RSF shell.
- HH** indicates a charcoal style core for wax removal and clean-up after a hermetic motor burnout.



For New Systems and Clean-Up After Burnout

Suction Line Filter-Drier Specifications

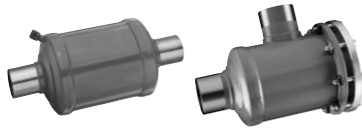

Type C-083-S-T-HH through C-609-S-T-HH
 Type RSF-487-T through RSF-9625-T
 Type C-30013-G through C-40033-G

Suction Line - Sealed Type

mm • kg

TYPE	CONNECTION SIZE Inches ODF Solder	OVERALL LENGTH mm	SOLDER SOCKET DEPTH mm	DIAMETER of BODY mm	SHIPPING WEIGHT kg
C-083-S-T-HH	3/8	135	11	67	0.6
C-084-S-T-HH	1/2	138	13	67	0.6
C-164-S-T-HH	1/2	154	13	76	0.8
C-165-S-T-HH	5/8	161	16	76	0.8
C-166-S-T-HH	3/4	172	16	76	0.8
C-167-S-T-HH	7/8	176	19	76	0.8
C-305-S-T-HH	5/8	234	16	76	1.6
C-306-S-T-HH	3/4	246	16	76	1.6
C-307-S-T-HH	7/8	249	19	76	1.6
C-309-S-T-HH	1-1/8	248	23	76	1.6
C-417-S-T-HH	7/8	249	19	89	2.0
C-419-S-T-HH	1-1/8	248	23	89	2.0
C-437-S-T-HH	7/8	263	19	121	3.6
C-439-S-T-HH	1-1/8	273	23	121	3.6
C-4311-S-T-HH	1-3/8	278	25	121	3.6
C-4313-S-T-HH	1-5/8	278	28	121	3.6
C-607-S-T-HH	7/8	405	19	76	2.7
C-609-S-T-HH	1-1/8	403	24	76	2.7

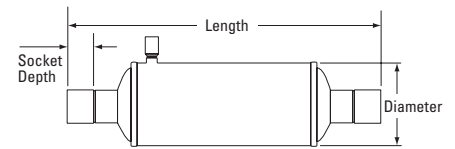

SEALED TYPE

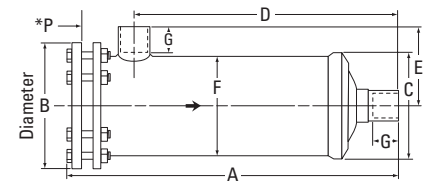

REPLACEABLE CORE TYPE



C-080 through C-600 Series have a maximum rated pressure of 44.8 bar.

Suction Line - Replaceable Core Type

mm • kg

TYPE	CONNECTION SIZE Inches ODF Solder	NO. OF CORES OR FILTER ELEMENTS	CORE OR ELEMENT PART NUMBER	MOUNTING BRACKET	SHELL DIMENSIONS mm							SHIPPING WEIGHT kg	
					A	B	C	D	E	F	G		*P
RSF-487-T	7/8	1	RC-4864-HH, RC-4864 or RCW-48 Cores	A-685	236	152	127	154	101	121	19	178	5.5
RSF-489-T	1-1/8				241			159	106		23		
RSF-4811-T	1-3/8				244			162	109		25		
RSF-4813-T	1-5/8				244			162	110		28		
RSF-4817-T	2-1/8				244			148	112		34		
RSF-4821-T	2-5/8				245			141	132		39		
RSF-9617-T	2-1/8	2	RPE-48-BD Element	A-175-2	380	191	159	288	112	152	35	816	7.7
RSF-9621-T	2-5/8				392			282	132		39		
RSF-9625-T	3-1/8				384			272	125		44		
For Systems Requiring the Maximum Amount of Desiccant													
C-30013-G	1-5/8	3	RC-10098-HH, RC-10098 or RCW-100 Cores	A-175-2	707	191	159	607	130	152	28	816	18.2
C-30017-G	2-1/8				708			610	135		35		
C-40017-G	2-1/8	4	RPE-100 Element	A-175-2	874	191	159	775	135	152	35	816	21.4
C-40021-G	2-5/8				893			776	146		38		21.4
C-40025-G	3-1/8				887			757	145		44		21.4
C-40029-G	3-5/8				887			764	146		39		22.3
C-40033-G	4-1/8				888			757	148		39		22.3

RSF-480, RSF-9600, C-30000 & C-40000 Series have a maximum rated pressure of 34.5 bar.

cUL_{us} Listed — Guide-SMGT-File No. SA-1756.

NOTE: Refer to Bulletin 80-10 for additional information on RSF shells. Screen P/N: 6171-5 is recommended when cores are used in these shells.

* "P" Dimension is the pull space required to change core.



For New Systems and Clean-Up After Burnout Suction Line Filter-Drier Specifications

Flow Capacity - Sealed Type

Tons • °F • psi

REFRIGERANT	134a			22					404A & 507				407A				407C	407F				410A
	40°F	20°F	0°F	40°F	20°F	0°F	-20°F	-40°F	20°F	0°F	-20°F	-40°F	20°F	0°F	-20°F	-40°F	40°F	20°F	0°F	-20°F	-40°F	40°F
EVAPORATOR TEMPERATURE																						
PRESSURE DROP (psi)	2.0	1.5	1.0	3.0	2.0	1.5	1.0	0.5	2.0	1.5	1.0	0.5	2.0	1.5	1.0	0.5	3.0	2.0	1.5	1.0	0.5	3.0
C-083-S-T-HH	1.3	0.9	0.5	2.1	1.3	0.9	0.5	0.2	1.2	0.8	0.5	0.2	1.3	0.9	0.5	0.2	2.0	1.4	0.9	0.5	0.2	2.7
C-084-S-T-HH	1.4	1.0	0.6	2.1	1.4	1.0	0.6	0.3	1.3	0.9	0.5	0.3	1.3	0.9	0.5	0.3	2.1	1.4	0.9	0.6	0.3	2.8
C-164-S-T-HH	1.7	1.1	0.7	2.7	1.7	1.1	0.7	0.3	1.6	1.0	0.6	0.3	1.7	1.1	0.6	0.3	2.7	1.8	1.2	0.7	0.3	3.6
C-165-S-T-HH	2.0	1.3	0.8	3.2	2.0	1.3	0.8	0.4	1.9	1.2	0.7	0.4	2.0	1.3	0.8	0.4	3.2	2.1	1.4	0.8	0.4	4.2
C-166-S-T-HH	2.6	1.7	1.0	4.0	2.5	1.6	1.0	0.5	2.4	1.6	0.9	0.5	2.5	1.6	1.0	0.5	3.9	2.7	1.7	1.1	0.5	5.2
C-167-S-T-HH	2.8	1.8	1.1	4.5	2.8	1.8	1.1	0.5	2.7	1.7	1.0	0.5	2.7	1.7	1.0	0.5	4.4	3.0	1.9	1.1	0.6	5.9
C-305-S-T-HH	2.2	1.4	0.8	3.4	2.1	1.4	0.8	0.4	2.0	1.3	0.8	0.4	2.1	1.3	0.8	0.4	3.4	2.2	1.5	0.9	0.4	4.4
C-306-S-T-HH	2.8	1.8	1.1	4.4	2.8	1.8	1.1	0.5	2.7	1.7	1.0	0.5	2.7	1.7	1.0	0.5	4.4	2.9	1.9	1.1	0.6	5.8
C-307-S-T-HH	3.4	2.2	1.3	5.3	3.3	2.2	1.3	0.6	3.2	2.0	1.2	0.96	3.2	2.1	1.2	0.6	5.3	3.5	2.3	1.4	0.7	7.0
C-309-S-T-HH	3.8	2.4	1.5	5.9	3.7	2.4	1.5	0.7	3.6	2.3	1.4	0.7	3.6	2.3	1.4	0.7	5.8	3.9	2.6	1.5	0.8	7.7
C-417-S-T-HH	3.8	2.5	1.5	6.0	3.8	2.5	1.5	0.7	3.6	2.3	1.4	0.7	3.7	2.4	1.4	0.7	6.0	4.0	2.6	1.6	0.8	7.9
C-419-S-T-HH	4.0	2.6	1.6	6.2	3.9	2.5	1.5	0.8	3.7	2.4	1.5	0.7	3.8	2.5	1.5	0.7	6.1	4.1	2.7	1.7	0.8	8.0
C-437-S-T-HH	5.1	3.3	2.1	8.0	5.0	3.3	2.0	1.0	4.8	3.1	1.9	0.9	4.9	3.2	1.9	1.0	7.9	5.3	3.5	2.1	1.1	10.4
C-439-S-T-HH	6.4	4.2	2.5	10.0	6.3	4.1	2.5	1.2	6.0	3.9	2.4	1.2	6.1	4.0	2.4	1.2	9.9	6.7	4.4	2.6	1.3	13.1
C-4311-S-T-HH	7.1	4.6	2.8	11.1	6.9	4.6	2.7	1.4	6.7	4.3	2.6	1.3	6.8	4.4	2.7	1.3	10.9	7.4	4.9	2.9	1.5	14.4
C-4313-S-T-HH	7.8	5.1	3.1	12.2	7.6	5.0	3.0	1.5	7.3	4.7	2.9	1.4	7.5	4.9	2.9	1.4	12.0	8.1	5.3	3.2	1.6	15.9
C-607-S-T-HH	4.2	2.7	1.7	6.7	4.2	2.7	1.6	0.8	4.0	2.6	1.6	0.8	4.1	2.6	1.6	0.8	6.6	4.4	2.9	1.7	0.8	8.7
C-609-S-T-HH	4.8	3.1	1.9	7.6	4.7	3.1	1.8	0.9	4.5	2.9	1.8	0.9	4.6	3.0	1.8	0.9	7.4	5.0	3.2	1.9	1.0	9.8

Flow Capacity - Replaceable Core Type

Tons • °F • psi

REFRIGERANT	134a			22					404A & 507				407A				407C		407F				410A		
	40°F	20°F	0°F	40°F	20°F	0°F	-20°F	-40°F	20°F	0°F	-20°F	-40°F	20°F	0°F	-20°F	-40°F	40°F	8.0*	2.0	1.5	1.0	0.5	3.0	8.0*	
EVAPORATOR TEMPERATURE																									
PRESSURE DROP (psi)	2.0	1.5	1.0	3.0	8.0*	2.0	1.5	1.0	0.5	2.0	1.5	1.0	0.5	2.0	1.5	1.0	0.5	3.0	8.0*	2.0	1.5	1.0	0.5	3.0	8.0*
RSF-487-T	6.4	4.2	2.5	10.1	17.5	6.3	4.1	2.5	1.2	6.1	4.0	2.3	1.2	6.1	3.9	2.4	1.1	10.0	17.3	6.6	4.3	2.6	1.3	12.6	21.9
RSF-489-T	7.8	5.1	3.1	12.2	21.1	7.6	5.0	3.0	1.5	7.3	4.8	2.8	1.4	7.4	4.8	2.8	1.4	12.0	20.7	8.0	5.2	3.1	1.6	15.3	26.4
RSF-4811-T	9.4	6.2	3.7	14.8	25.6	9.3	6.1	3.6	1.8	8.9	5.8	3.4	1.7	9.0	5.8	3.4	1.7	14.6	25.3	9.8	6.4	3.7	1.9	18.5	32.0
RSF-4813-T	10.1	6.7	4.0	15.9	27.5	10.0	6.5	3.9	1.9	9.6	6.2	3.6	1.8	9.7	6.2	3.7	1.8	15.7	27.2	10.5	6.8	4.1	2.0	19.9	34.4
RSF-4817-T	11.0	7.2	4.4	17.2	29.8	10.8	7.1	4.2	2.1	10.4	6.8	3.9	2.0	10.5	6.8	4.0	2.0	17.0	29.4	11.4	7.4	4.4	2.2	21.5	37.3
RSF-4821-T	11.9	7.8	4.7	18.6	32.2	11.6	7.6	4.6	2.3	11.2	7.3	4.3	2.2	11.2	7.3	4.3	2.2	18.4	31.6	12.2	8.0	4.8	2.4	23.3	40.3
RSF-9617-T	16.1	13.0	8.1	29.7	49.0	19.8	13.7	8.7	4.7	17.9	12.2	7.6	4.0	19.2	13.1	8.2	4.4	28.6	47.2	20.9	14.3	9.1	4.9	37.1	61.3
RSF-9621-T	18.7	13.0	8.1	29.7	50.7	19.8	13.7	8.7	4.7	17.9	12.2	7.6	4.0	19.2	13.1	8.2	4.4	28.9	49.8	20.9	14.3	9.1	4.9	37.1	61.3
RSF-9625-T	19.2	13.0	8.1	30.0	51.9	20.0	13.7	8.7	4.7	17.9	12.2	7.6	4.0	19.4	13.1	8.2	4.4	29.7	51.0	21.1	14.3	9.1	4.9	37.5	63.4
C-30013-G	16.9	11.0	6.7	26.6	46.0	16.7	10.9	6.5	3.2	16.0	10.3	6.2	3.1	16.3	10.5	6.3	3.1	26.3	42.8	17.7	11.5	6.9	3.4	33.3	64.9
C-30017-G	17.2	11.1	6.8	27.0	46.7	16.9	11.1	6.6	3.3	16.2	10.4	6.3	3.1	16.5	10.7	6.4	3.2	26.7	43.3	17.9	11.7	7.1	3.5	33.8	58.4
C-40017-G	21.0	13.6	8.3	32.9	56.9	20.6	13.5	8.1	4.0	19.8	12.8	7.2	3.8	20.1	13.1	7.8	3.9	32.4	52.8	21.9	14.3	8.6	4.3	41.1	71.1
C-40021-G thru C-40033-G	21.0	13.6	8.3	32.9	56.9	20.6	13.5	8.1	4.0	19.8	12.8	7.2	3.8	20.1	13.1	7.8	3.9	32.4	52.8	21.9	14.3	8.6	4.3	41.1	71.1

*Denotes TEMPORARY INSTALLATION. Cores for system clean-up; RPE-48-BD or RPE-100 Filter Elements are to be installed after clean-up. Rated in accordance with ANSI/AHRI Standard 730.

SELECTION INSTRUCTIONS

Except for the values in bold (R-22/R-407C/R-410A at 40°F/4°C; 8 psi/0.55 bar pressure drop), the flow capacities are rated at the maximum recommended pressure drop for **permanent** installation.

To ensure the suction line filter-drier has ample contaminant removal ability, selection must be based on flow capacity

and the amount of desiccant required for system clean-up. The suction line filter-drier must be large enough to adequately remove acid, moisture and solid contaminants without causing nuisance plug-ups. Sizing is especially important for sealed type suction line filter-driers since they should be sized to clean a small system with one service call.

To reduce the pressure drop through replaceable core shells, substitute cores with filter elements (see page 26) after the system has been cleaned up. The 6171-5 screen should be discarded when cores are replaced with RPE-48-BD elements in RSF shells.



For New Systems and Clean-Up After Burnout Suction Line Filter-Drier Specifications

Flow Capacity - Sealed Type

kW • °C • bar

REFRIGERANT	134a			22					404A & 507				407A				407C		407F				410A
EVAPORATOR TEMPERATURE	5°C	-5°C	-15°C	5°C	-5°C	-15°C	-30°C	-40°C	5°C	-15°C	-30°C	-40°C	5°C	-15°C	-30°C	-40°C	5°C	-5°C	-15°C	-30°C	-40°C	5°C	
PRESSURE DROP (bar)	0.14	0.10	0.07	0.21	0.14	0.10	0.07	0.03	0.14	0.10	0.07	0.03	0.14	0.10	0.07	0.03	0.21	0.14	0.10	0.07	0.03	0.21	
C-083-S-T-HH	4.6	3.2	1.8	7.4	4.6	3.2	1.8	0.7	4.2	2.8	1.8	0.7	4.4	3.0	1.7	0.7	7.0	4.8	3.3	1.8	0.7	9.5	
C-084-S-T-HH	4.9	3.5	2.1	7.4	4.9	3.5	2.1	1.1	4.6	3.2	1.8	1.1	4.6	3.0	1.8	0.9	7.4	4.9	3.3	2.0	1.0	9.8	
C-164-S-T-HH	6.0	3.9	2.5	9.5	6.0	3.9	2.5	1.1	5.6	3.5	2.1	1.1	5.8	3.7	2.2	1.1	9.5	6.3	4.1	2.4	1.2	12.6	
C-165-S-T-HH	7.0	4.6	2.8	11.2	7.0	4.6	2.8	1.4	6.7	4.2	2.5	1.4	6.9	4.5	2.7	1.3	11.2	7.5	4.9	3.0	1.5	14.7	
C-166-S-T-HH	9.1	6.0	3.5	14.0	8.8	5.6	3.5	1.8	8.4	5.6	3.2	1.8	8.6	5.6	3.4	1.7	13.7	9.3	6.1	3.7	1.8	18.3	
C-167-S-T-HH	9.8	6.3	3.9	15.8	9.8	6.3	3.9	1.8	9.5	6.0	3.5	1.8	9.5	6.1	3.6	1.7	15.4	10.4	6.7	4.0	1.9	20.7	
C-305-S-T-HH	7.7	4.9	2.8	11.9	7.4	4.9	2.8	1.4	7.0	4.6	2.8	1.4	7.2	4.7	2.8	1.3	11.9	7.9	5.1	3.0	1.5	15.4	
C-306-S-T-HH	9.8	6.3	3.9	15.4	9.8	6.3	3.9	1.8	9.5	6.0	3.5	1.8	9.4	6.1	3.6	1.8	15.4	10.2	6.7	4.0	1.9	20.4	
C-307-S-T-HH	11.9	7.7	4.6	18.6	11.6	7.7	4.6	2.1	11.2	7.0	4.2	2.1	11.3	7.3	4.3	2.1	18.6	12.3	8.0	4.7	2.3	24.6	
C-309-S-T-HH	13.3	8.4	5.3	20.7	13.0	8.4	5.3	2.5	12.6	8.1	4.9	2.5	12.7	8.2	4.9	2.4	20.4	13.8	9.0	5.4	2.7	27.0	
C-417-S-T-HH	13.3	8.8	5.3	21.1	13.3	8.8	5.3	2.5	12.6	8.1	4.9	2.5	13.0	8.4	5.0	2.4	21.1	14.0	9.2	5.5	2.7	27.0	
C-419-S-T-HH	14.0	9.1	5.6	21.8	13.7	8.8	5.3	2.8	13.0	8.4	5.3	2.5	13.3	8.7	5.2	2.6	21.4	14.5	9.5	5.8	2.9	28.1	
C-437-S-T-HH	17.9	11.6	7.4	28.1	17.6	11.6	7.0	3.5	16.8	10.9	6.7	3.2	17.3	11.3	6.8	3.4	27.7	18.7	12.3	7.4	3.7	36.5	
C-439-S-T-HH	22.5	14.7	8.8	35.1	22.1	14.4	8.8	4.2	21.1	13.7	8.4	4.2	21.5	14.0	8.4	4.1	34.7	23.4	15.3	9.2	4.6	46.0	
C-4311-S-T-HH	24.9	16.1	9.8	39.0	24.2	16.1	9.5	4.9	23.5	15.1	9.1	4.6	23.9	15.6	9.4	4.6	38.3	25.9	17.1	10.3	5.2	50.5	
C-4313-S-T-HH	27.4	17.9	10.9	42.8	26.7	17.6	10.5	5.3	25.6	16.5	10.2	4.9	26.2	17.1	10.2	5.0	42.1	28.5	18.7	11.2	5.6	55.8	
C-607-S-T-HH	14.7	9.5	6.0	23.5	14.7	9.5	5.6	2.8	14.0	9.1	5.6	2.8	14.3	9.2	5.5	2.7	23.2	15.5	10.1	6.0	3.0	30.5	
C-609-S-T-HH	16.8	10.9	6.7	26.7	16.5	10.9	6.3	3.2	15.8	10.2	6.3	3.2	16.1	10.4	6.2	3.0	26.0	17.4	11.4	6.8	3.4	34.4	

Flow Capacity - Replaceable Core Type

kW • °C • bar

REFRIGERANT	134a			22					404A & 507				407A				407C		407F				410A		
EVAPORATOR TEMPERATURE	5°C	-5°C	-15°C	5°C	-5°C	-15°C	-30°C	-40°C	5°C	-15°C	-30°C	-40°C	5°C	-15°C	-30°C	-40°C	5°C	-5°C	-15°C	-30°C	-40°C	5°C			
PRESSURE DROP (bar)	0.14	0.10	0.07	0.21	0.55*	0.14	0.10	0.07	0.03	0.14	0.10	0.07	0.03	0.14	0.10	0.07	0.03	0.21	0.55*	0.14	0.10	0.07	0.03	0.21	0.55*
RSF-487-T	22.5	14.7	8.8	35.5	61.4	22.1	14.4	8.8	4.2	21.4	14.0	8.1	4.2	21.4	13.8	8.3	4.0	35.1	60.7	23.3	15.1	9.1	4.4	44.2	76.9
RSF-489-T	27.4	17.9	10.9	42.8	74.1	26.7	17.6	10.5	5.3	25.6	16.8	9.8	4.9	25.9	16.8	10.0	5.0	42.1	72.7	28.1	18.4	11.0	5.5	53.7	92.7
RSF-4811-T	33.0	21.8	13.0	51.9	89.9	32.6	21.4	12.6	6.3	31.2	20.4	11.9	6.0	31.6	20.5	11.9	6.0	51.2	88.8	34.4	22.4	13.1	6.6	64.9	112.3
RSF-4813-T	35.5	23.5	14.0	55.8	96.5	35.1	22.8	13.7	6.7	33.7	21.8	12.6	6.3	34.0	21.8	12.9	6.3	55.1	95.5	37.0	23.9	14.2	7.0	69.8	120.7
RSF-4817-T	38.6	25.3	15.4	60.4	104.6	37.9	24.9	14.7	7.4	36.5	23.9	13.7	7.0	36.7	23.9	13.9	7.0	59.7	103.2	39.9	26.1	15.3	7.7	75.5	130.9
RSF-4821-T	41.8	27.4	16.5	65.3	113.0	40.7	26.7	16.1	8.1	39.3	25.6	15.1	7.7	39.5	25.5	15.3	7.6	64.6	110.9	42.9	27.9	16.8	8.5	81.8	141.5
RSF-9617-T	56.5	45.6	28.4	104.2	172.0	69.5	48.1	30.5	16.5	62.8	42.8	26.7	14.0	67.4	46.1	28.9	15.6	100.4	165.7	73.2	50.3	31.8	17.3	130.2	215.2
RSF-9621-T	65.6	45.6	28.4	104.2	178.0	69.5	48.1	30.5	16.5	62.8	42.8	26.7	14.0	67.4	46.1	28.9	15.6	101.4	174.8	73.2	50.3	31.8	17.3	130.2	215.2
RSF-9625-T	67.4	45.6	28.4	105.3	182.2	70.2	48.1	30.5	16.5	62.8	42.8	26.7	14.0	68.0	46.1	28.9	15.6	104.2	179.0	73.9	50.3	31.8	17.3	131.6	222.5
C-30013-G	59.3	38.6	23.5	93.4	161.5	58.6	38.3	22.8	11.2	56.2	36.2	21.8	10.9	57.2	37.0	22.1	10.8	92.3	150.2	62.1	40.5	24.3	12.0	116.9	227.8
C-30017-G	60.4	39.0	23.9	94.8	163.9	59.3	39.0	23.2	11.6	56.9	36.5	22.1	10.9	57.9	37.7	22.5	11.1	93.7	152.0	62.8	41.2	24.8	12.3	118.6	205.0
C-40017-G	73.7	47.7	29.1	115.5	199.7	72.3	47.4	28.4	14.0	69.5	44.9	25.3	13.3	70.6	46.0	27.4	13.5	113.7	185.3	76.9	50.3	30.2	15.0	144.3	249.6
C-40021-G thru C-40033-G	73.7	47.7	29.1	115.5	199.7	72.3	47.4	28.4	14.0	69.5	44.9	25.3	13.3	70.6	46.0	27.4	13.5	113.7	185.3	76.9	50.3	30.2	15.0	144.3	249.6

*Denotes TEMPORARY INSTALLATION. Cores for system clean-up; RPE-48-BD or RPE-100 Filter Elements are to be installed after clean-up. Rated in accordance with ANSI/AHRI Standard 730.

Catch-All[®] Compact Style Suction Line Filter-Driers



Type C-144-S-TT-HH through C-149-S-TT-HH
 Maximum Rated Pressure of 650 psi / 44.8 bar

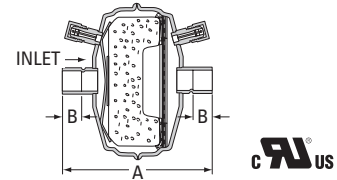

PROVEN BENEFITS:

- **Short overall length**, suitable for cramped piping situations — shorter than other similar type filter-driers.
- Suitable for use on **1 through 5 ton air conditioning systems**, with suction line sizes in the range of 1/29 to 1-1/89. Also applicable on the common suction line of heat pump systems.
- **The famous Sporlan HH core** removes all types of contaminants including moisture, acid, dirt, and sludge. A blend of two desiccants, plus activated charcoal, gives maximum performance.
- **Access valves** permit measuring the pressure drop across the filter-drier during clean-up, following a hermetic motor burnout.

APPLICATION

The short overall length of these filter-driers permit easy installation, even on systems with restricted space. While designed for the minimum possible overall length, these filter-driers are suitable for use on most air conditioning systems. The filter-drier has two access

Specifications

TYPE	CONNECTION SIZE Inches ODF Solder	OVERALL LENGTH "A"		SOLDER SOCKET DEPTH "B"		DIAMETER OF BODY		SHIPPING WEIGHT	
		Inches	mm	Inches	mm	Inches	mm	lb	kg
C-144-S-TT-HH	1/2	4.14	105	.50	13	4.44	113	2.0	0.9
C-145-S-TT-HH	5/8	4.38	111	.62	16				
C-146-S-TT-HH	3/4	4.83	123	.69	18				
C-147-S-TT-HH	7/8	4.97	126	.75	19				
C-149-S-TT-HH	1-1/8	4.93	125	.96	24				

Volume of desiccant is 14 cubic inches (229 cm³). Filtering area is 27 square inches (174 cm²).
 CRI US Recognized Component — Guide-SMGT2-File No. SA-1756.

valves for measuring the pressure drop across the filter-drier core during the clean-up process.

Heat pump systems frequently have cramped piping in the very compact cabinet. The C-140 Series Catch-All is not a reversible filter-drier, therefore it must be installed in the common suction line. The service technician needs a short suction line filter-drier to fit in this restricted space. The C-140 Series Catch-All meets this essential need.

CONSTRUCTION

The core is held in place by a leaf spring at the inlet end. Filtration occurs on the core

surface, and a 100 mesh screen is used as a safety filter at the outlet end. The screen and core are sealed to the shell wall with a fiberglass pad. The threaded valve core for each access valve is supplied in a separate envelope. This way the heat sensitive valve core can be installed after brazing the Catch-All into the line. The Catch-All utilizes copper connections for ease in brazing with any type of alloy.

While designed for use in the suction line these filter-driers may be installed in the liquid line, if desired under unusual circumstances. The performance of these filter-driers in the liquid line is similar to the popular C-160 Series Catch-All Filter-Driers.



Compact Style Suction Line Filter-Driers



Type C-144-S-TT-HH through C-149-S-TT-HH
Maximum Rated Pressure of 650 psi / 44.8 bar

Flow Capacity*

Tons • °F • psi

TYPE	REFRIGERANT																	
	134a			22					407A			407C	407F			410A		
	EVAPORATOR TEMPERATURE °F																	
	0	20	40	-40	-20	0	20	40	-40	-20	0	20	40	-40	-20	0	20	40
	PRESSURE DROP – psi																	
1	1-1/2	2	1/2	1	1-1/2	2	3	1/2	1	1-1/2	2	3	1/2	1	1-1/2	2	3	
C-144-S-TT-HH	0.5	0.8	1.3	0.2	0.4	0.9	1.3	2.2	0.2	0.4	0.9	1.2	2.1	0.2	0.4	0.9	1.4	2.7
C-145-S-TT-HH	0.8	1.3	2.1	0.4	0.8	1.4	2.2	3.6	0.4	0.8	1.3	2.1	3.5	0.4	0.9	1.5	2.3	4.6
C-146-S-TT-HH	1.1	1.8	2.9	0.6	1.2	2.0	3.0	4.9	0.6	1.2	1.9	3.0	4.8	0.6	1.3	2.1	3.2	6.2
C-147-S-TT-HH	1.3	2.1	3.2	0.7	1.3	2.2	3.3	5.4	0.7	1.3	2.1	3.2	5.3	0.7	1.4	2.3	3.5	6.8
C-149-S-TT-HH	1.6	2.7	4.2	0.9	1.7	2.9	4.4	7.1	0.8	1.7	2.8	4.3	7.0	0.9	1.9	3.1	4.7	9.0

Flow Capacity*

kW • °C • bar

TYPE	REFRIGERANT																	
	134a			22					407A			407C	407F			410A		
	EVAPORATOR TEMPERATURE °C																	
	-20	-5	0	-40	-30	-20	-5	5	-40	-30	-15	-5	5	-40	-30	-15	-5	5
	PRESSURE DROP – bar																	
0.07	0.10	0.14	0.03	0.07	0.10	0.14	0.21	0.03	0.07	0.10	0.14	0.21	0.03	0.07	0.10	0.14	0.21	
C-144-S-TT-HH	1.8	2.8	4.6	0.7	1.4	3.2	4.6	7.7	0.7	1.4	3.0	4.4	7.4	0.8	1.5	3.3	4.9	9.5
C-145-S-TT-HH	2.8	4.6	7.4	1.4	2.8	4.9	7.7	12.6	1.3	2.8	4.7	7.4	12.3	1.5	3.1	5.2	8.0	16.1
C-146-S-TT-HH	3.9	6.3	10.2	2.1	4.2	7.0	10.5	17.2	2.0	4.1	6.8	10.4	16.8	2.2	4.5	7.4	11.2	21.8
C-147-S-TT-HH	4.6	7.4	11.2	2.5	4.6	7.7	11.6	19.0	2.3	4.6	7.5	11.4	18.6	2.5	5.0	8.2	12.4	23.9
C-149-S-TT-HH	5.6	9.5	14.7	3.2	6.0	10.2	15.4	24.9	3.0	5.9	9.9	15.1	24.6	3.3	6.6	10.8	16.4	31.6

Rated in accordance with ANSI/AHRI Standard 730.

*The water capacity and acid capacity of the C-140 Series are comparable to the popular C-160-S-T-HH Series Filter-Drier. Specific values are not listed since the industry has no standard method for testing the water capacity or acid removal ability in the suction line of refrigerant systems. The flow capacity information above permits selecting C-140 Series Catch-Alls for various conditions with confidence.

TEST All[®] Acid Test Kit



Tests Mineral, Alkylbenzene, and POE Lubricants

- Thoroughly Field Proven
- Takes the Guesswork Out of Service Work

THE TA-1 ACID TEST KIT OFFERS THESE OUTSTANDING BENEFITS:

BUILDS CUSTOMER CONFIDENCE

Show the test results of the acid test kit to customers, or perform the test in their presence. In this way they realize you are using the most up-to-date scientific method for system maintenance. Showing customers the test results will also help to convince them to spend the money necessary to do a proper clean-up job. Customers who are thoroughly confident of your abilities will be more interested in establishing preventive maintenance programs.

ACCURATE AND RELIABLE

Using a simple, scientific method, you can precisely measure the amount of acid in a lubricant sample taken from a contaminated system. The test procedure has been proven by extensive field experience.

CONVENIENT

The TA-1 is simple and convenient to use. The kit has pre-measured solutions supplied in bottles with screw caps for easy handling. The kit may be used on the job site, or a lubricant sample can be saved and tested in the presence of the equipment owner.

LUBRICANT SAMPLE USED FOR TEST

Since lubricant is the scavenger, it gives the best indication of acid in the system. Less than an ounce of lubricant is required.

QUICK TO USE

Once the lubricant sample is obtained...it will take only minutes to perform the test. Simply mix the solutions and lubricant to be tested. Shake, and the resulting color tells the complete story.

COST

The TA-1 kit is a very inexpensive way to assess the vulnerability of expensive system components to harmful acidic conditions.

GENERAL INSTRUCTIONS

A refrigeration system suspected of an acidic lubricant condition should be tested to determine if it is within an acceptable limit before extensive damage is done and/or hermetic motor burnout occurs.

The Acid Test Kit is a simple and direct service tool that “takes the guesswork out of service work.” The test can be done in the field, or service shop to determine if the acid content of the lubricant is within safe operational limits.

After mixing the solutions and adding the lubricant, the color should be judged immediately. Allowing the solution to set an hour or more may give a false reading. The chart shows the color change points of the TA-1 Acid Test Kit with mineral, alkylbenzene, and POE lubricant.

The solutions in the kit are stable, but are sensitive to light and heat. Store the kit, in the product box, in a cool, dry place.

LUBRICANT TYPE	SATISFACTORY ACID LEVEL		MARGINAL ACID LEVEL		UNSATISFACTORY ACID LEVEL	
	SOLUTION COLOR	ACID NUMBER	SOLUTION COLOR	ACID NUMBER	SOLUTION COLOR	ACID NUMBER
Mineral or Alkylbenzene	Purple or Red	Less than 0.05	—	—	Orange or Yellow	0.05 or Greater
POE	Purple or Red	Less than 0.17	Orange	0.17 to 0.23	Yellow	0.23 or Greater

The TA-1 Kit is designed to serve as a guideline for testing POE lubricants since the industry has not established a maximum acid level for POE lubricants. Always follow the equipment manufacturer’s recommendations.

The TA-1 kit should not be used on systems that contain a lubricant additive leak detector. The additives can interfere with the color change point of the acid test kit.

CENTRIFUGAL SYSTEMS

Most of the lubricants used in centrifugal systems contain additives. These additives react like an acid even though the lubricant is not contaminated. Therefore, the TA-1 cannot be used to test many centrifugal lubricants. However, the kit can be used to test certain refrigerants themselves. Refrigerants 11, 113 or 123 from these systems can be tested directly. This permits routine maintenance and a check on the system following clean-up of a contaminated system.

Catch-All® Accessories

MOUNTING BRACKETS

Order Separately

Mounting Brackets designed especially for **replaceable core type Catch-All Filter-Driers and RSF shells** are available. All brackets are supplied with a bolt, nut, and washer.

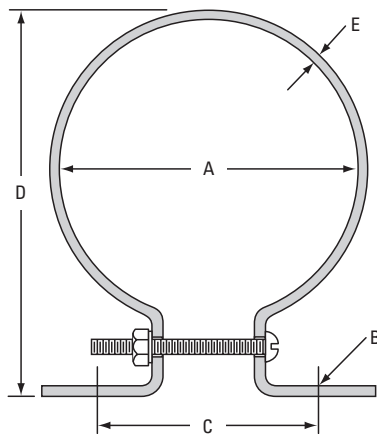

A-685

Mounting Bracket for shell types C-480 thru C-19200 Series and RSF shells. **ONE** bracket per package. Depending on shell size and installation requirements, more than one bracket may be required. Catch-Alls larger than the C-480 and RSF-480 Series shells generally require two brackets.

A-175-1

Mounting Bracket for shell types C-R424-G, C-R425-G, and C-R427-G **ONLY**. **ONE** bracket per package. Usually one bracket is adequate for mounting these Catch-Alls.

A-175-2

Mounting Bracket for shell types C-30000 and C-40000 Series. **TWO** brackets per package. Two brackets are generally adequate for mounting these large Catch-Alls.

Mounting Bracket Dimensions

MODEL NUMBER	DIMENSIONS									
	A		B		C		D		E	
	Inches	mm	Inches	mm	Inches	mm	Inches	mm	Inches	mm
A-685	4.75	121	.41 x .81 Slot	10 x 21 Slot	3.50	89	6.12	155	0.12	3.0
A-175-1	3.50	89			3.50	89	4.62	117	0.12	3.0
A-174-2	6.00	152			4.00	102	7.44	189	0.12	3.0

JP-232 CAP TUBE ADAPTER

To simplify the application of **Catch-All Filter-Driers** on systems with cap tubes, Sporlan has designed a brass adapter that fits all standard 1/4" ODF solder fittings. This adapter can be used with the C-032-S, C-052-S, and C-082-S models. As shown in the illustration, one end of the adapter is suitable for 0.125" OD tubing and the other is suitable for cap tubes of

.087", .090", or .093" OD. This adapter **CANNOT** be used with the C-032-CAP or C-032-CAP-T Catch-Alls.

The adapter can be brazed to the capillary tubing and the unit fitting in one operation. These adapters are available from all Sporlan wholesalers. Request **part number: JP-0232-000**.

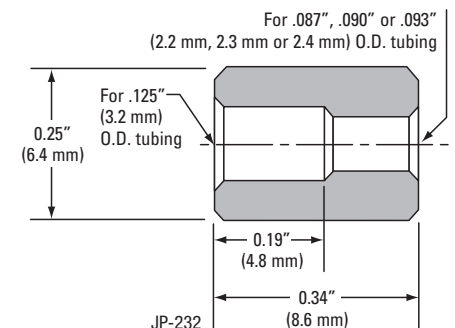



Atex Compliance

■ ATEX COMPLIANCE

The products within this Bulletin are designed to be used with A2L and A3 refrigerants (flammable) along with complying with the European Directives (97/23/CE) “Pressure Equipment Directive” and (94/9/CE) “ATEX Directive” for equipment intended for use in potentially explosive atmospheres.

Products bearing this phrase “II 3 G TX Ta -46°C to +65°C” have been evaluated and tested to the requirements found in the ATEX Directive 94/9/CE. The products will fall under “II 3 G TX Ta -46°C to +65°C” (-50°F to 149°F) and are considered suitable for installation in potentially explosive atmospheres.

For safety reasons, only authorized persons who are certified in installing and maintaining refrigeration and air conditioning systems containing flammable hydrocarbons must do the installation and maintenance. All local requirements or codes regarding use of hydrocarbons

in refrigeration and air conditioning systems must be followed.

The refrigeration or air conditioning system must be designed so no abnormal impact (e.g. vibration, liquid hammer, pressure pulsations) can create risk for damage to the system.

When replacing parts, **ONLY** use Sporlan replacement parts. Parker Hannifin – Sporlan Division takes no responsibility for the classification of the refrigeration and/or air conditioning systems.

SAFETY

When used in a zone noted as Hazardous (ATEX), the possibility of Electrostatic charge build up on the external surface has to be prevented either during installation or service of this product. If the Sporlan product must be handled, do so using a damp cloth in order to avoid electrostatic buildup. Protect the Sporlan product against external impact that may cause a spark.

Personnel handling or working on or with this product must be qualified for that task. In an ATEX zone, the personnel must be educated in the risks of explosion. It is the responsibility of the installer to check the installation so that there is no leakage after it is installed, especially in case of explosive atmospheres. The contaminant control device or valve and its control must not undergo any modification without prior approval from the Sporlan Division. Sporlan is not responsible for any damage which may be caused by the misuse or installation of Sporlan parts, accessories or controls which are not original parts.

SPECIAL CONDITIONS OF USE

To avoid electrostatic charging steps must be taken to ensure the equipotential bonding is maintained. **WARNING: To avoid a possible electrostatic charge, only clean with a damp cloth.** Operating fluid temp range shall be limited to a range from -46°C (-50°F) to 65°C (149°F).

OFFER OF SALE

The items described in this document and other documents and descriptions provided by Parker Hannifin Corporation, its subsidiaries and its authorized distributors (“Seller”) are hereby offered for sale at prices to be established by Seller. This offer and its acceptance by any customer (“Buyer”) shall be governed by all of the following Terms and Conditions. Buyer’s order for any item described in its document, when communicated to Seller verbally, or in writing, shall constitute acceptance of this offer. All goods, services or work described will be referred to as “Products”.

1. Terms and Conditions. Seller’s willingness to offer Products, or accept an order for Products, to or from Buyer is subject to these Terms and Conditions or any newer version of the terms and conditions found on-line at www.parker.com/saleterms/. Seller objects to any contrary or additional terms or conditions of Buyer’s order or any other document issued by Buyer.

2. Price Adjustments; Payments. Prices stated on Seller’s quote or other documentation offered by Seller are valid for 30 days, and do not include any sales, use, or other taxes unless specifically stated. Unless otherwise specified by Seller, all prices are F.C.A. Seller’s facility (INCOTERMS 2010). Payment is subject to credit approval and is due 30 days from the date of invoice or such other term as required by Seller’s Credit Department, after which Buyer shall pay interest on any unpaid invoices at the rate of 1.5% per month or the maximum allowable rate under applicable law.

3. Delivery Dates; Title and Risk; Shipment. All delivery dates are approximate and Seller shall not be responsible for any damages resulting from any delay. Regardless of the manner of shipment, title to any products and risk of loss or damage shall pass to Buyer upon placement of the products with the shipment carrier at Seller’s facility. Unless otherwise stated, Seller may exercise its judgment in choosing the carrier and means of delivery. No deferral of shipment at Buyer’s request beyond the respective dates indicated will be made except on terms that will indemnify, defend and hold Seller harmless against all loss and additional expense. Buyer shall be responsible for any additional shipping charges incurred by Seller due to Buyer’s acts or omissions.

4. Warranty. Seller warrants that the Products sold hereunder shall be free from defects in material or workmanship for a period of twelve months from the date of delivery to Buyer or 2,000 hours of normal use, whichever occurs first. The prices charged for Seller’s products are based upon the exclusive limited warranty stated above, and upon the following disclaimer: **DISCLAIMER OF WARRANTY: THIS WARRANTY COMPRISES THE SOLE AND ENTIRE WARRANTY PERTAINING TO PRODUCTS PROVIDED HEREUNDER. SELLER DISCLAIMS ALL OTHER WARRANTIES, EXPRESS AND IMPLIED, INCLUDING DESIGN, MERCHANTABILITY AND FITNESS FOR A PARTICULAR PURPOSE.**

5. Claims; Commencement of Actions. Buyer shall promptly inspect all Products upon delivery. No claims for shortages will be allowed unless reported to the Seller within 10 days of delivery. No other claims against Seller will be allowed unless asserted in writing within 30 days after delivery. Buyer shall notify Seller of any alleged breach of warranty within 30 days after the date the defect is or should have been discovered by Buyer. Any action based upon breach of this agreement or upon any other claim arising out of this sale (other than an action by Seller for an amount due on any invoice) must be commenced within 12 months from the date of the breach without regard to the date breach is discovered.

6. LIMITATION OF LIABILITY. UPON NOTIFICATION, SELLER WILL, AT ITS OPTION, REPAIR OR REPLACE A DEFECTIVE PRODUCT, OR REFUND THE PURCHASE PRICE. **IN NO EVENT SHALL SELLER BE LIABLE TO BUYER FOR ANY SPECIAL, INDIRECT, INCIDENTAL OR CONSEQUENTIAL DAMAGES ARISING OUT OF, OR AS THE RESULT OF, THE SALE, DELIVERY, NON-DELIVERY, SERVICING, USE OR LOSS OF USE OF THE PRODUCTS OR ANY PART THEREOF, OR FOR ANY CHARGES OR EXPENSES OF ANY NATURE INCURRED WITHOUT SELLER’S WRITTEN CONSENT, EVEN IF SELLER HAS BEEN NEGLIGENT, WHETHER IN CONTRACT, TORT OR OTHER LEGAL THEORY. IN NO EVENT SHALL SELLER’S LIABILITY UNDER ANY CLAIM MADE BY BUYER EXCEED THE PURCHASE PRICE OF THE PRODUCTS.**

7. User Responsibility. The user, through its own analysis and testing, is solely responsible for making the final selection of the system and Product and assuring that all performance, endurance, maintenance, safety and warning requirements of the application are met.

The user must analyze all aspects of the application and follow applicable industry standards and Product information. If Seller provides Product or system options, the user is responsible for determining that such data and specifications are suitable and sufficient for all applications and reasonably foreseeable uses of the Products or systems.

8. Loss to Buyer’s Property. Any designs, tools, patterns, materials, drawings, confidential information or equipment furnished by Buyer or any other items which become Buyer’s property, will be considered obsolete and may be destroyed by Seller after two consecutive years have elapsed without Buyer ordering the items manufactured using such property. Seller shall not be responsible for any loss or damage to such property while it is in Seller’s possession or control.

9. Special Tooling. A tooling charge may be imposed for any special tooling, including without limitation, dies, fixtures, molds and patterns, acquired to manufacture Products. Such special tooling shall be and remain Seller’s property notwithstanding payment of any charges by Buyer. In no event will Buyer acquire any interest in apparatus belonging to Seller which is utilized in the manufacture of the Products, even if such apparatus has been specially converted or adapted for such manufacture and notwithstanding any charges paid by Buyer. Unless otherwise agreed, Seller shall have the right to alter, discard or otherwise dispose of any special tooling or other property in its sole discretion at any time.

10. Buyer’s Obligation; Rights of Seller. To secure payment of all sums due or otherwise, Seller shall retain a security interest in the goods delivered and this agreement shall be deemed a Security Agreement under the Uniform Commercial Code. Buyer authorizes Seller as its attorney to execute and file on Buyer’s behalf all documents Seller deems necessary to perfect its security interest.

11. Improper use and Indemnity. Buyer shall indemnify, defend, and hold Seller harmless from any claim, liability, damages, lawsuits, and costs (including attorney fees), whether for personal injury, property damage, patent, trademark or copyright infringement or any other claim, brought by or incurred by Buyer, Buyer’s employees, or any other person, arising out of: (a) improper selection, improper application or other misuse of Products purchased by Buyer from Seller; (b) any act or omission, negligent or otherwise, of Buyer; (c) Seller’s use of patterns, plans, drawings, or specifications furnished by Buyer to manufacture Product; or (d) Buyer’s failure to comply with these terms and conditions. Seller shall not indemnify Buyer under any circumstance except as otherwise provided.

12. Cancellations and Changes. Orders shall not be subject to cancellation or change by Buyer for any reason, except with Seller’s written consent and upon terms that will indemnify, defend and hold Seller harmless against all direct, incidental and consequential loss or damage. Seller may change product features, specifications, designs and availability with notice to Buyer.

13. Limitation on Assignment. Buyer may not assign its rights or obligations under this agreement without the prior written consent of Seller.

14. Force Majeure. Seller does not assume the risk and shall not be liable for delay or failure to perform any of Seller’s obligations by reason of circumstances beyond the reasonable control of Seller (hereinafter “Events of Force Majeure”). Events of Force Majeure shall include without limitation: accidents, strikes or labor disputes, acts of any government or government agency, acts of nature, delays or failures in delivery from carriers or suppliers, shortages of materials, or any other cause beyond Seller’s reasonable control.

15. Waiver and Severability. Failure to enforce any provision of this agreement will not waive that provision nor will any such failure prejudice Seller’s right to enforce that provision in the future. Invalidation of any provision of this agreement by legislation or other rule of law shall not invalidate any other provision herein. The remaining provisions of this agreement will remain in full force and effect.

16. Termination. Seller may terminate this agreement for any reason and at any time by giving Buyer

thirty (30) days written notice of termination. Seller may immediately terminate this agreement, in writing, if Buyer: (a) commits a breach of any provision of this agreement (b) appoints a trustee, receiver or custodian for all or any part of Buyer’s property (c) files a petition for relief in bankruptcy on its own behalf, or by a third party (d) makes an assignment for the benefit of creditors, or (e) dissolves or liquidates all or a majority of its assets.

17. Governing Law. This agreement and the sale and delivery of all Products hereunder shall be deemed to have taken place in and shall be governed and construed in accordance with the laws of the State of Ohio, as applicable to contracts executed and wholly performed therein and without regard to conflicts of laws principles. Buyer irrevocably agrees and consents to the exclusive jurisdiction and venue of the courts of Cuyahoga County, Ohio with respect to any dispute, controversy or claim arising out of or relating to this agreement.

18. Indemnity for Infringement of Intellectual Property Rights. Seller shall have no liability for infringement of any patents, trademarks, copyrights, trade dress, trade secrets or similar rights except as provided in this Section. Seller will defend and indemnify Buyer against allegations of infringement of U.S. patents, U.S. trademarks, copyrights, trade dress and trade secrets (“Intellectual Property Rights”). Seller will defend at its expense and will pay the cost of any settlement or damages awarded in an action brought against Buyer based on an allegation that a Product sold pursuant to this Agreement infringes the Intellectual Property Rights of a third party. Seller’s obligation to defend and indemnify Buyer is contingent on Buyer notifying Seller within ten (10) days after Buyer becomes aware of such allegations of infringement, and Seller having sole control over the defense of any allegations or actions including all negotiations for settlement or compromise. If a Product is subject to a claim that it infringes the Intellectual Property Rights of a third party, Seller may, at its sole expense and option, procure for Buyer the right to continue using the Product, replace or modify the Product so as to make it noninfringing, or offer to accept return of the Product and return the purchase price less a reasonable allowance for depreciation. Notwithstanding the foregoing, Seller shall have no liability for claims of infringement based on information provided by Buyer, or directed to Products delivered hereunder for which the designs are specified in whole or part by Buyer, or infringements resulting from the modification, combination or use in a system of any Product sold hereunder. The foregoing provisions of this Section shall constitute Seller’s sole and exclusive liability and Buyer’s sole and exclusive remedy for infringement of Intellectual Property Rights.

19. Entire Agreement. This agreement contains the entire agreement between the Buyer and Seller and constitutes the final, complete and exclusive expression of the terms of sale. All prior or contemporaneous written or oral agreements or negotiations with respect to the subject matter are herein merged.

20. Compliance with Law, U. K. Bribery Act and U.S. Foreign Corrupt Practices Act. Buyer agrees to comply with all applicable laws and regulations, including both those of the United Kingdom and the United States of America, and of the country or countries of the Territory in which Buyer may operate, including without limitation the U. K. Bribery Act, the U.S. Foreign Corrupt Practices Act (“FCPA”) and the U.S. Anti-Kickback Act (the “Anti-Kickback Act”), and agrees to indemnify and hold harmless Seller from the consequences of any violation of such provisions by Buyer, its employees or agents. Buyer acknowledges that they are familiar with the provisions of the U. K. Bribery Act, the FCPA and the Anti-Kickback Act, and certifies that Buyer will adhere to the requirements thereof. In particular, Buyer represents and agrees that Buyer shall not make any payment or give anything of value, directly or indirectly to any governmental official, any foreign political party or official thereof, any candidate for foreign political office, or any commercial entity or person, for the purpose of influencing such person to purchase products or otherwise benefit the business of Seller.



Parker Hannifin Corporation
Sporlan Division
206 Lange Drive • Washington, MO 63090 USA
phone 636 239 1111 • fax 636 239 9130
www.sporlan.com